



Operating and Instruction Manual

Manual No. YB
Revision 0-600 w/12 March 2014 Errata

MODEL YB8 STATIONARY PERISTALTIC SAMPLERS



Manning Environmental, Inc.
101 Bar T Drive
Florence, Texas 76527-4445 USA
Office: (800) 863-9337
(254) 793-9955
Fax: (254) 793-9965
www.manningenvironmental.com

Manning Environmental Limited Factory Warranty

Manning Environmental, Inc., warrants this product to the original purchaser against any defects that are due to faulty workmanship or material for a period of one year (365 days) from the date of shipment.

During the warranty period Manning Environmental, Inc. will repair or replace, at its sole discretion, any defective equipment or parts. Manning's liability is strictly limited to repair and/or replacement. Any product repaired or replaced under this warranty will be warranted only for the remainder of the original product warranty period.

This warranty does not apply to consumable products or consumable components of products such as, but not limited to tubing, intake hose, differential pressure switches and bottles.

Items may not be returned without authorization from Manning Environmental, Inc.

This warranty applies only to products sold under the Manning trademark and is the sole express warranty made by Manning Environmental, Inc. All implied warranties, including without limitation, the warranties of merchantability or fitness for a particular purpose, are disclaimed.*

Limitations:

This warranty does not cover the following:

1. Damage caused by acts of God, natural disaster, labor unrest, acts of war (declared or undeclared), terrorism, civil strife or acts of any governmental jurisdiction
2. Damage caused by normal wear, neglect, misuse, accident, corrosion or improper application or installation
3. Damage caused by any repair, attempted repair or modifications not authorized by Manning Environmental, Inc.
4. Any product not used in accordance with the instructions furnished by Manning Environmental, Inc.
5. Freight charges to return merchandise to Manning Environmental, Inc.
6. Freight charges on expedited or express shipment of warranted parts or products.
7. Travel and lodging fees associated with on-site warranty repair
8. Manning 6.1 cubic foot refrigerators, which are covered under the refrigerator manufacturer's warranty
9. Labor performed at the factory to clean the equipment so that it can be safely and properly repaired

This warranty constitutes the final, complete, and exclusive statement of warranty terms. Manning Environmental, Inc. does not authorize any other person to make any other warranties or representations on its behalf.

In no event shall Manning Environmental, Inc. be liable for any incidental or consequential damages of any kind for breach of warranty or negligence. The remedies of repair or replacement as stated above are the exclusive remedies for the breach of this warranty.

A Return Material Authorization (RMA) must be obtained prior to sending any equipment to Manning for warranty service. Contact the Manning Service Department at:

Manning Environmental, Inc.
101 Bar T Drive
Florence, Texas 76527-4445
Phone: 254-793-9955, Fax: 252-793-9965.

**Some states within the United States do not allow the disclaimer of implied warranties and if this is true in your state the above limitation may not apply to you. This warranty gives you specific rights- you may also have other rights that vary from state to state.*

Table Of Contents

Section Contents – Installation and Operation

Introduction.....	Page A-1
Hardware Page	Page A-2
Functional Specifications.....	Page A-2
Size.....	Page A-2
Weight.....	Page A-2
Environmental Protection	Page A-2
Sample Cooling	Page A-2
Temperature Limits.....	Page A-2
Sample Pump	Page A-2
Safety	Page A-2
Pump Tubing.....	Page A-2
Tube Life.....	Page A-2
Maximum Lift.....	Page A-2
Transport Velocity	Page A-2
Sample Volume.....	Page A-2
Accuracy	Page A-2
Repeatability	Page A-2
Liquid Sensor	Page A-2
Controller	Page A-3
Electronics.....	Page A-3
Internal Clock.....	Page A-3
Internal Battery	Page A-3
Power	Page A-3
Battery Back-Up	Page A-3
Analog Input	Page A-3
Subassemblies.....	Page A-3
Electronics Enclosure.....	Page A-3
The Controller.....	Page A-3
Peristaltic Pump	Page A-4
Liquid Sensor	Page A-5
Refrigerator	Page A-5
Wetted Parts	Page A-5
Intake Hose	Page A-5
Strainer	Page A-5
Pump Tubing.....	Page A-6
Discharge Tubing.....	Page A-6
Bottle Full Sensor	Page A-6
Sample Bottles	Page A-7
Assembly.....	Page A-8

Assembling the Model YB8 Sampler	Page A-8
Refrigerator	Page A-8
Electronics Enclosure.....	Page A-9
Distribution Assembly Installation	Page A-10
Single Bottle Sampling	Page A-10
Multiple Bottle Sampling.....	Page A-10
Suspension Plate Installation	Page A-10
Distributor Assembly	Page A-10
Bottle Installation.....	Page A-13
One Liter and Half-Liter Plastic Bottles	Page A-13
Spout Position	Page A-13
Installing The Sampler.....	Page A-13
Connecting Power.....	Page A-14
Sample Intake Line	Page A-14
Intake Hose Placement.....	Page A-14
Running a Test Cycle.....	Page A-15
The Sampling Cycle.....	Page A-15
Sample Recovery	Page A-16
External Connections	Page A-17
Contact In & Analog In Connections.....	Page A-17
Bottle Full Sensor & Stepper Motor Connections	Page A-17
Bottle Full/Stepper Motor	Page A-17
Contact Closure.....	Page A-18
Analog Signal (Optional).....	Page A-18

Section Contents – Programming

Introduction.....	Page B-1
Sampler Configuration.....	Page B-1
Sampling Modes	Page B-1
Multi-Bottle Sampling Modes	Page B-1
Single Bottle Modes.....	Page B-1
<RESET>.....	Page B-2
<TEST CYCLE>	Page B-2
<BOTTLE ADV>.....	Page B-2
<CLEAR>.....	Page B-2
<CLOCK>	Page B-2
<DISPLAY>	Page B-2
*.....	Page B-2
EEEE.....	Page B-2
Key Not Active	Page B-2
Display Information	Page B-3
Time of Day	Page B-3
Program Status	Page B-3
Sampler Ready	Page B-3

Programming.....	Page B-3
Active Program	Page B-3
Sampler Configuration Functions.....	Page B-4
*99 Sampler Set-Up.....	Page B-4
*20 Volume Calibration.....	Page B-7
*19 Pump Utilities	Page B-9
*91 Data Logging	Page B-11
ID Menu	Page B-12
View Menu.....	Page B-12
Exit Menu.....	Page B-16
Download Menu.....	Page B-16
Clear Menu.....	Page B-18
*14 Clear Log Data.....	Page B-18
Analog Option Programming.....	Page B-19
Totalizing	Page B-19
*08 Analog Display Routine.....	Page B-20
Add-On Programming Functions.....	Page B-22
Multiple Bottles per Sampling Event.....	Page B-22
Multiple Samples per Bottle	Page B-22
Delay Start - Time.....	Page B-24
*15 - Active Sampling	Page B-24-A
General Programs.....	Page B-25
Time Mode - *START.....	Page B-25
Time Mode - Single Time Interval	Page B-26
Flow Mode.....	Page B-28
Flow Mode - Pulse Accumulation	Page B-29
Multi-Bottle Sampling Programs.....	Page B-30
*01 Flow Mode - Independently Time Spout Advance.....	Page B-30
*02 Flow Mode - Time Interval Override.....	Page B-31
*03 Flow Mode - External Event.....	Page B-32
*04 Time Mode - Multiple Intervals.....	Page B-33
*07 Flow Mode - Time Delay Interval	Page B-35
Analog Sampling Programs	Page B-36
*05 Flow Mode - Totalizing Analog	Page B-36
*06 Analog Level Mode	Page B-38
*09 Hydrologic Level Event Mode.....	Page B-41
Multi-Bottle Flow Composite Programs.....	Page B-45
*10 Flow Mode - Multiple Bottle Composite.....	Page B-45
*11 Flow Mode - Totalizing Analog Multiple Bottle Composite.....	Page B-47
*12 Flow Mode - Multiple Bottle Composite with Bottle Groups	Page B-49
*13 Flow Mode- Totalizing Analog Multiple Bottle Composite with Bottle Groups.....	Page B-52

Section Contents – Maintenance

Maintenance	Page C-1
Suggested Maintenance Schedule	Page C-1
Peristaltic Pump	Page C-2
Replacement of Pump Tubing	Page C-3
Cleaning the Control Panel and Electronics Enclosure	Page C-6
Cleaning the Wetted Parts	Page C-6
Intake Hose	Page C-7
Liquid Sensor	Page C-7
Bottle Full Sensor (Single Bottle Units Only)	Page C-8
Spout (Multiple Bottle Units Only)	Page C-8
Sample Containers	Page C-8
Refrigerator	Page C-8
Environmental Protection	Page C-10
Removing and Replacing the Controller	Page C-10
Troubleshooting	Page C-11
System Non-Responsive	Page C-11
Works Inconsistently	Page C-11
Weak Draw	Page C-11
Pump Operates but no Fluid	Page C-12
Pump Rotor Does Not Rotate	Page C-12
Purges Constantly	Page G-12
Low Sample Volume	Page C-12
Excessive Sample Volume	Page C-12
Controller Does not Respond to Command	Page C-12
Keypad Inoperative	Page C-12
*99 Self Test Indicates Error	Page C-12

Section Contents - Appendices

Glossary	
Appendix A	Page D-1
How to Return Equipment	Page D-1
Address for Repairs	Page D-1
Parts List	
Errata	

Installation and Operation

Section Contents

Introduction.....	Page A-1
Hardware Page	Page A-2
Functional Specifications.....	Page A-2
Size.....	Page A-2
Weight.....	Page A-2
Environmental Protection	Page A-2
Sample Cooling	Page A-2
Temperature Limits.....	Page A-2
Sample Pump	Page A-2
Safety	Page A-2
Pump Tubing.....	Page A-2
Tube Life.....	Page A-2
Maximum Lift.....	Page A-2
Transport Velocity	Page A-2
Sample Volume.....	Page A-2
Accuracy	Page A-2
Repeatability	Page A-2
Liquid Sensor	Page A-2
Controller	Page A-3
Electronics.....	Page A-3
Internal Clock.....	Page A-3
Internal Battery	Page A-3
Power	Page A-3
Battery Back-Up	Page A-3
Analog Input	Page A-3
Subassemblies	Page A-3
Electronics Enclosure.....	Page A-3
The Controller.....	Page A-3
Peristaltic Pump	Page A-4
Liquid Sensor	Page A-5
Refrigerator	Page A-5
Wetted Parts	Page A-5
Intake Hose	Page A-5
Strainer.....	Page A-5
Pump Tubing.....	Page A-6
Discharge Tubing.....	Page A-6
Bottle Full Sensor	Page A-6
Sample Bottles	Page A-7

Assembly.....	Page A-8
Assembling the Model YB8 Sampler	Page A-8
Refrigerator	Page A-8
Electronics Enclosure.....	Page A-9
Distribution Assembly Installation	Page A-10
Single Bottle Sampling	Page A-10
Multiple Bottle Sampling.....	Page A-10
Suspension Plate Installation	Page A-10
Distributor Assembly	Page A-10
Bottle Installation.....	Page A-13
One Liter and Half-Liter Plastic Bottles	Page A-13
Spout Position	Page A-13
Installing The Sampler	Page A-13
Connecting Power	Page A-14
Sample Intake Line	Page A-14
Intake Hose Placement.....	Page A-14
Running a Test Cycle.....	Page A-15
The Sampling Cycle.....	Page A-15
Sample Recovery	Page A-16
External Connections	Page A-17
Contact In & Analog In Connections.....	Page A-17
Bottle Full Sensor & Stepper Motor Connections	Page A-17
Bottle Full/Stepper Motor	Page A-17
Contact Closure.....	Page A-18
Analog Signal (Optional).....	Page A-18

Introduction

Congratulations on the purchase of a Manning Environmental, Inc. Model YB8 Sampler. The model selected is the latest in a long line of state of the art equipment produced for over twenty three years by Manning Environmental Inc. Based on this experience, if there is one thing Manning can claim it is that we know samplers. There are Manning samplers still used in regular service today that are over twenty years old. It is almost impossible to find an organization with the commitment of producing equipment with such a history of reliability, dependability, quality and value as exhibited by Manning samplers. Even so, improvement is a never ending goal at Manning. We are always interested in the perceptions and experiences of our users. If there are any suggestions or comments on our equipment, this manual, or anything Manning does, please feel free to contact us.

The YB8 is a stationary peristaltic pump based model which can automatically collect and hold Non-Toxic, Toxic, and Suspended Solid samples from a liquid source. The unit was designed from the ground up with active user participation to ensure the features and options that are important to field use were incorporated into the unit. It employs a high speed, peristaltic pump to draw the samples and an industrial grade refrigeration unit to cool and maintain them at the EPA recommended 4⁰C. Backed by Manning's reputation for quality and dependability, it will provide years of reliable service.

Even if the sampler will not be used immediately upon receipt, unpack and examine it. This will help to familiarize the user with the equipment. Verify that all of the parts have been received and that no damage has occurred in shipment. If damage is noticed, immediately report the extent of it to both the transportation company and to Manning Environmental Inc. In addition, check the packing list to verify that it matches the items sent and that all accessories ordered are included with the shipment. Manning strives for 100 percent accuracy in the delivery of our equipment, but even with the most stringent quality assurance, mistakes do occur. Omissions, damage, or mistakes must be reported to Manning Environmental Inc. within 10 working days of receipt of the shipment.

This manual is designed to communicate a complete understanding of the equipment, its operation, maintenance, and functions. Manning recommends this manual and the equipment be examined completely before placing the unit into service. Manning's commitment to producing reliable, top quality products is legendary, but the possibility of breakdown or malfunction always exists. This manual should enable the diagnosis and solving of many potential problems. If the problem cannot be solved, please feel free to call our service department at 1-800-863-9337 to obtain help. Our first priority is making sure the experience with Manning equipment is an excellent one. In almost all instances the difficulty can be addressed over the phone, but in the rare instance it cannot, the equipment may need to be sent back to Manning for service. Please contact our customer service department at 1-800-863-9337 to obtain a Return Authorization Number. Then follow the shipping instructions that will be given. Please note the malfunction on the paper work so a diagnosis and a solution to the problem can be arrived at with the least amount of delay.

We recommend the following steps before attempting to use the sampler:

1. Review this manual. **Read the errata sheets at the end of this manual for the latest updates.**
2. Follow the instructions beginning on page 1-8 to assemble the YB8.
3. Set the time and activate a test cycle.

4. Program the YB8.

Hardware

Functional Specifications:

Size	Control Unit: 10.75" (27.305cm)W x 7" (17.78cm)H x 9.75" (24.765cm)D Refrigeration Unit: 23.875" (60.65cm)W x 34.5" (87.63cm)H x 24" (60.96cm)D Total Unit: 23.875" (60.65cm)W x 41.5" (105.41cm)H x 24" (60.96cm)D
Weight	Dry Weight: 110 lb (49.89 kg) with refrigerator.
Environmental Protection	Nema 4X, 6 housing around electromechanical components.
Sample Cooling	Industrial Grade refrigeration unit.
Temperature Limits	0°C to 50°C (32°F to 122°F) without optional enclosure and heater.
Sample Pump	High Speed peristaltic, dual roller design with impact and corrosion resistant Delrin [®] plastic pump body.
Safety	Integral safety kill switch. Ensures when the clear plastic face plate is removed from the pump, it prevents accidental powered rotation.
Pump Tubing	3/8" ID by 5/8" OD by 1/8" thick medical grade silicone rubber pump tubing.
Tube Life	Recommended maximum of 1,000,000 pump revolutions based on a standard sample. A standard sample equates to 5ft of head, 10 foot PVC intake tube, and 200 ml sample size.
Maximum Lift	28 ft (8.5344 m).
Transport Velocity	Minimum of 3 ft/s at 3 ft of lift (0.9144 m/s at 1 m) and 2.0 ft/s at 20 ft of lift (0.6096 m/s at 6.1 m).
Sample Volume	Programmed directly in increments of 1 milliliter up to a maximum of 9,999 ml.
Accuracy	± 10ml or ± 10% of the programmed volume, whichever is greater.
Repeatability	± 5ml or ± 5% of the average largest and smallest sample volume in a sample set, whichever is greater.
Liquid Sensor	Continuity type or Ultrasonic (optional)

Controller	Microprocessor based 1 board system which controls all functions of the unit.
Membrane Switch	Ergonomically designed, hermetically Sealed, 24 key, multiple function, with 2 line by 20 character alphanumeric backlighted display.
Electronics	100% Solid State.
Internal Clock	Indicates real time with ± 1 min/month accuracy.
Internal Battery	5 year internal lithium battery to maintain program logic, RAM memory, real time clock and date.
Power	115 volt AC, 60 Hz. - Standard 220 volt AC, 50 Hz. - Optional
Battery Back-Up	Optional 12 VDC battery backup for continued operation in case of 115 volt power failure. Continues to operate the sampling control unit only, not the refrigerator.
Analog Input	4-20 mA - Optional

Subassemblies

The sampler consists of three major subassemblies: the electronics enclosure, the refrigerator, and the wetted parts. As a unit these subassemblies form an environmentally resistant enclosure.

Electronics Enclosure

The electronics enclosure includes the microprocessor-based controller, the peristaltic pump, and the liquid sensor. Constructed of structural resin, the enclosure conforms to Nema 4X,6 requirements when latched.

The Controller

The controller electronics consists of 1 board. The board converts outside power to the appropriate internal use and controls the input/output signals associated with the sampler. The CPU board contains a Z180 microprocessor, RAM and ROM memory, and interfaces for the keyboard, and the display. The micro board also contains the logic for the liquid sensor and the RPM counter. The user communicates to the sampler via a 24 key multiple function membrane switch. The keys are clearly marked with their designated functions. An internal battery maintains the program logic, RAM memory, and the controller's real-time clock and date function. The electronics are mounted on the back of the controller.



Figure 1 - Electronics Enclosure

Peristaltic Pump

The Manning Model YB8 employs a high speed, dual roller, vertically mounted, peristaltic pump. The pump is belt driven by a 12VDC industrial grade motor. This ensures quite, smooth performance even while the unit is subjected to very intense performance conditions. It utilizes a face plate constructed of clear PVC for easy visual identification of pump parameters, such as tube alignment, and spindle and roller operation. The pump body is made of impact and corrosion resistant Delrin[®] plastic for long life. It securely holds the pump tubing in place by firmly clamping the two halves of the pump case together. The pump is capable of vertical lifts of up to 28 feet and produces sample transport velocities of 2.0 feet per second over a wide range of draw heights

Liquid Sensor

The Model YB8 utilizes a liquid sensor, located near the entrance to the peristaltic pump, which is capable of detecting the presence of source fluid as it approaches the pump inlet. The sensor is either a continuity type probe (base) or an ultrasonic sensor (optional). The liquid sensor is used for two reasons. It enables the sampler to rinse the intake line. After the initiation of a sampling sequence the first operation is to turn on the peristaltic pump. The pump begins rotating counter-clockwise causing air to be forced out of the intake tubing. After the set amount of purge time has elapsed, the unit will reverse the pump so the rollers are moving in a clockwise direction. This creates vacuum in the pump tube, which in turn causes the source liquid, to begin traveling up the intake line. As soon as the fluid reaches the liquid sensor, the sampler will immediately recognize that fluid has reached the inlet to the pump. It will instantaneously reverse the direction of the pump (rollers will be moving in a counter-clockwise rotation), sending the water that had been drawn up back out of the intake line. This in effect rinses the line. When the unit has performed the set number of rinses, a sample will be drawn. The rinse option is set in *99 (configuration mode). The sampler can be programmed to not rinse the line or to rinse the line up to 3 times.

It makes it possible for the sampler to deliver precise, repeatable samples even in changing lift conditions.



Figure 3 - Keypad

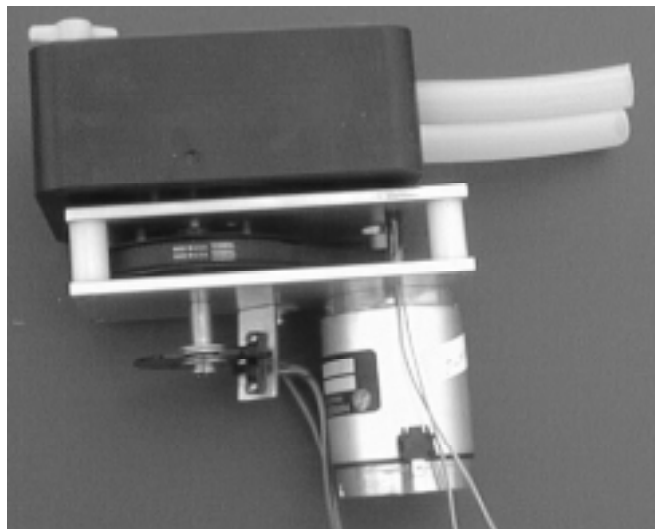

Figure 2 - Pump Assembly

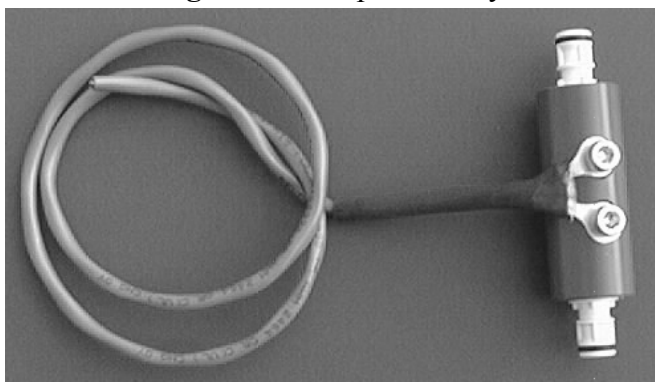

Figure 4 - Liquid Sensor - Continuity Type

Whenever a sampling sequence is initiated the sampler follows the steps outlined above, and draws a sample. The controller then determines the transit time of the sample to reach the liquid sensor. Assume for example there was an increase in the amount of lift from the source liquid to the unit. This would increase the time needed for a sample to reach the liquid sensor and the pump. The controller, in a case such as this, will automatically compensate for the change in lift by increasing the amount of time the peristaltic pump is able to pull source liquid. This ensures the sampler has enough time to collect the correct amount of sample fluid. The compensation applies to either an increase or decrease in lift height.

Refrigerator

The refrigerator is an industrial grade unit with the ability to cool and maintain samples at the EPA recommended 4°C. Modifications have been performed on the refrigerator that enable it to withstand even the harshest environments. The condenser has been baked dip-coated with enamel and the copper refrigerant lines are coated with asphalt cork tape to prevent hydrogen sulfide gas from attacking the copper lines and the brazed joints. The thermostat is located inside the refrigerator which affords it additional protection from the environment. The evaporation coils and cabinet both have two coats of baked on acrylic enamel with the cabinet having the additional protection of an iron phosphate pre-treatment. Both the fan motor and the compressor are designed for greater durability and resistance to atmospheric attack. The unit boasts extensive insulation for maximum cooling retention, and a full perimeter magnetic door gasket with a urethane coating to resist corrosion and seal the cold inside. The door is also available with an optional locking hasp to prevent unauthorized entry. The sample containers, suspension plate, and distributor arm for multiple bottle operation are located within the environmentally controlled chamber of the refrigerator.



Figure 5 - Refrigerator

Wetted Parts

Wetted parts are those pieces of the sampler that come in direct contact with the sample liquid. The main components of the wetted parts for the Manning Model YB8 are the intake hose and strainer, the pump tubing, the discharge tubing, the bottle full sensor (in single bottle units) the distribution assembly (in multiple bottle units) and the sample bottles. If the source liquid to be sampled is a non-priority pollutant (Non-Toxic) then all parts that touch the liquid are either PVC (Polyvinyl Chloride), medical grade silicone rubber, ABS (Acrylonitrile Butadiene Styrene) plastic, or Stainless Steel. Parts in contact with a sample source that is a priority pollutant (Toxic) are required to be Teflon[®], glass, stainless steel, or medical grade silicone rubber. These materials are recognized and accepted as non-contaminating materials. This permits the sampling of a wide variety of toxic pollutants such as hydrocarbons and chlorine-based compounds.

Intake Hose

The 3/8" ID by 5/8" OD intake hose is constructed of either PVC (Polyvinyl Chloride) or PTFE. You can differentiate the hoses by their physical characteristics. The PVC is flexible and slightly tacky to the touch. The PTFE is not very flexible and is also very smooth and slick to the touch.



Figure 6 - Intake Hose

Strainer

The 3/8" ID strainer is available in stainless steel, or PVC. By placing holes no larger than 3/8" ID along the length of the strainer, the intake of large particles that can plug the hose or any part of the sampler is prevented. Since the strainer is also weighted, it keeps the hose inlet at the desired level in the source liquid.

**Figure 7 - Strainers****Pump Tubing**

The pump tubing Manning Environmental Inc. supplies for the Model YB8 is medical grade silicone rubber.

**Figure 8 - Pump Tubing****Discharge Tubing**

The 3/8" ID by 5/8" OD discharge tubing is also medical grade silicone rubber.

Bottle Full Sensor

The bottle full sensor is only used on single bottle applications. It is a cylinder, with a hole in the middle, to allow the discharge tube to pass through. Constructed of PVC it has two stainless steel rods that protrude vertically downward from the main body of the sensor. The user positions the bottle full sensor in the container with the ends of the rods at the highest point water should be allowed to rise. Once the water level has risen and contacts the rods, a change in continuity is detected alerting the sampling unit that the liquid in the container has reached the maximum level allowed by the user. This ends the sampling cycle

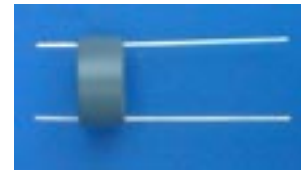
**Bottle Full Sensor**

Sample Bottles

The bottles are constructed of either polyethylene or glass.

NOTE: The sampler is field convertible from multiple bottle to single bottle.
Contact the Manning Environmental Parts Department for assistance.

Single Bottle Sampling	Multiple Bottle Sampling
One (1) - 5 gallon HDPE carboy One (1) - 4 gallon polyethylene carboy One (1) - 2.5 gallon glass bottle One (1) - 2.5 gallon polyethylene	Twenty-four (24) - 500mL Polyethylene bottles Twenty-four (24) - 1000mL Polyethylene bottles

Assembly

Assembling the Model YB8 Sampler

The unit is normally shipped assembled with accessories packed inside the refrigerator.

Refrigerator

There are several things to keep in mind before installing the refrigerator. The location is important. It is best to locate the unit out of direct sunlight and away from heat sources. It is best to locate the unit at least two inches away from any kind of wall. Ventilation is required from the bottom front section of the unit. Keep this area open and clear of any obstructions. It is recommended not to use a power cord to power the unit. It is best if the unit can be plugged directly into the appropriate power supply outlet. The refrigeration system is equipped with a power supply cord that has a three-pronged grounded plug. It must be plugged into a mating grounding type receptacle in accordance with the National Electrical Code and applicable local codes and ordinances. If the circuit does not have a grounding type receptacle, it is the responsibility and obligation of the customer to exchange the existing receptacle in accordance with the National Electrical Code and applicable local codes and ordinances. The third ground prong should not under any circumstances, be cut or removed. All U.L listed refrigerated products are equipped with this type of plug, except hazardous location models which are to be wired to comply with the National Electrical Code, Article 501-4 for Class I Divisions 1 and 2

Things to remember about the refrigerator:

- A. Allow 24 hours for your refrigerator to reach a new temperature setting.
- B. The motor will start and stop often. It must do this to maintain the temperature you select.
- C. Keep your refrigerator as level as possible
- D. Unplug the refrigerator before working on anything with the electrical system.
- E. Exercise caution when sweeping, vacuuming or mopping near the front of the unit. Damage to the grill can occur.
- F. For all cleaning of the refrigerator, mix 2 tablespoons baking soda into 1 quart warm water or use mild soap. Do not use strong cleaners or scouring powders or pads.
- G. Keep all flame or sparks away from flammable material storage refrigerators when opening the door to remove or store commodities.
- H. Disconnect electrical power before removing electrical plug

Unpack the refrigerator by removing the bands at the top and bottom of the refrigerator box and lifting the box off of the refrigeration unit. Open the refrigerator door and check for various components that might be inside the refrigerator. Items are often packed inside the unit to minimize shipping space. Check the items you have received against the packing list. Call Manning immediately if you cannot match the packing list to the items shipped. Manning strives for 100% accurate shipments, but mistakes do happen, so please call Manning immediately if there is a discrepancy.

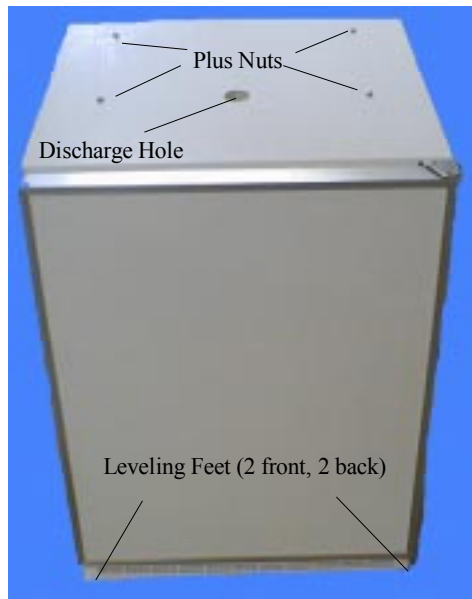

Figure 10 - Refrigerator

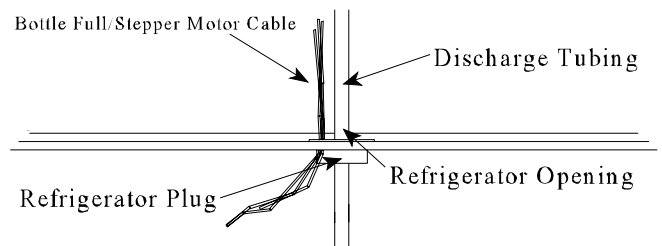

Figure 12 - Refrigeration Hole Placement

1. Once you have unpacked the unit, locate the four feet for the refrigerator (they are in a small plastic bag inside the refrigerator, with the refrigerator owners manual).
2. With the refrigerator empty, carefully tip it and screw a foot into the threaded hole in the bottom of each corner.
3. Adjust the feet so the refrigerator is level and does not rock.
4. Plug the refrigerator in and begin the cooling the unit down. Manning recommends using a water proof thermometer and a liter of water to monitor the temperature of the water within the refrigerator. This will give a more accurate representation of the actual temperature of the samples once sampling begins. You should allow at least 24 hours for the refrigerator to reach a stable condition.

NOTE: Be careful not to scratch any painted surfaces. The surfaces are painted with corrosion resistant paint. Scratches in the paint minimize this protection.

Electronics Enclosure

1. On top of the refrigerator there will be 4 screws inserted into 4 plus nut holes. Remove the screws from the holes and set them aside in a safe place.
2. Place the electronics enclosure on top of the refrigerator so the holes in the PVC mounting bars match up with the threaded inserts in the refrigerator. The front (latches are in the front) should be facing the door of the refrigerator and the peristaltic pump should be on the right.
3. Insert the screws and tighten snugly.
4. Thread the discharge tube into the center hole in the refrigerator. There will be a black rubber plug that fits into the discharge hole. This plug is split to accept either the bottle full sensor cable or the stepper motor cable depending on the configuration that you ordered. The cable fits inside the plug.



Figure 11 - Refrigerator Plug

Distribution Assembly Installation

Single Bottle Sampling

1. Center the sample bottle in the refrigerator.
2. Run the discharge hose through the Bottle Full sensor ring and then place it at the desired height in the bottle. To adjust the position simply slide the bottle full sensor either up or down the discharge hose.
3. Connect the Bottle Full sensor probes to the female contacts on the bottle full cable coming from the electronics enclosure into the refrigerator.



Figure 13
- Bottle Full Sensor

Multiple Bottle Sampling

Suspension Plate Installation

Position the suspension plate so the handles are on the sides. Slide the plate onto the top rails in the refrigerator. The plate should be flush with the front of the refrigerator so it does not interfere with the drain trough in the rear.

Distributor Assembly

1. Verify that the spout is correctly aligned on the distribution bracket. The spout should be centered on the bracket side when the spout is rotated to the side (3 o'clock position).

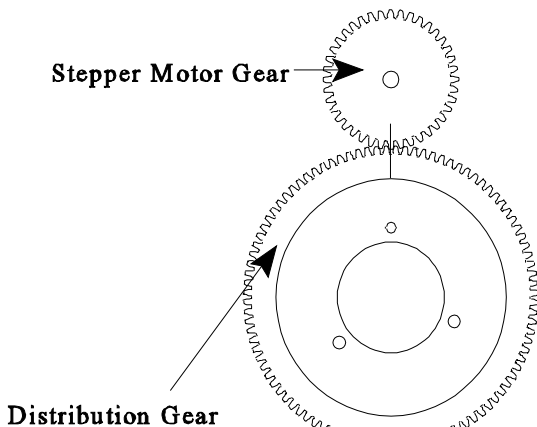

Figure 14 - Gear Arrangement

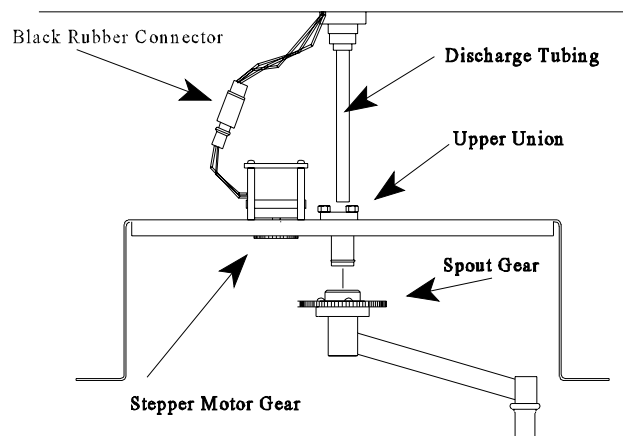

Figure 15 - Distribution System

2. Place the distribution assembly on the suspension plate with the plate handles poking through the slots in the distribution assembly.
3. Insert the discharge tube into the upper union. The discharge tube must be flush against the union to prevent leaking.
4. Mate the black connectors. (Applying non-conductive grease will help if disassembly is required later.)

There are wire racks inside the refrigerator so the distribution assembly can be parked out of the way when removing the suspension plate and/or bottles. This makes it unnecessary to remove the discharge tube from the spout union or to de-mate the connector when removing the plate.

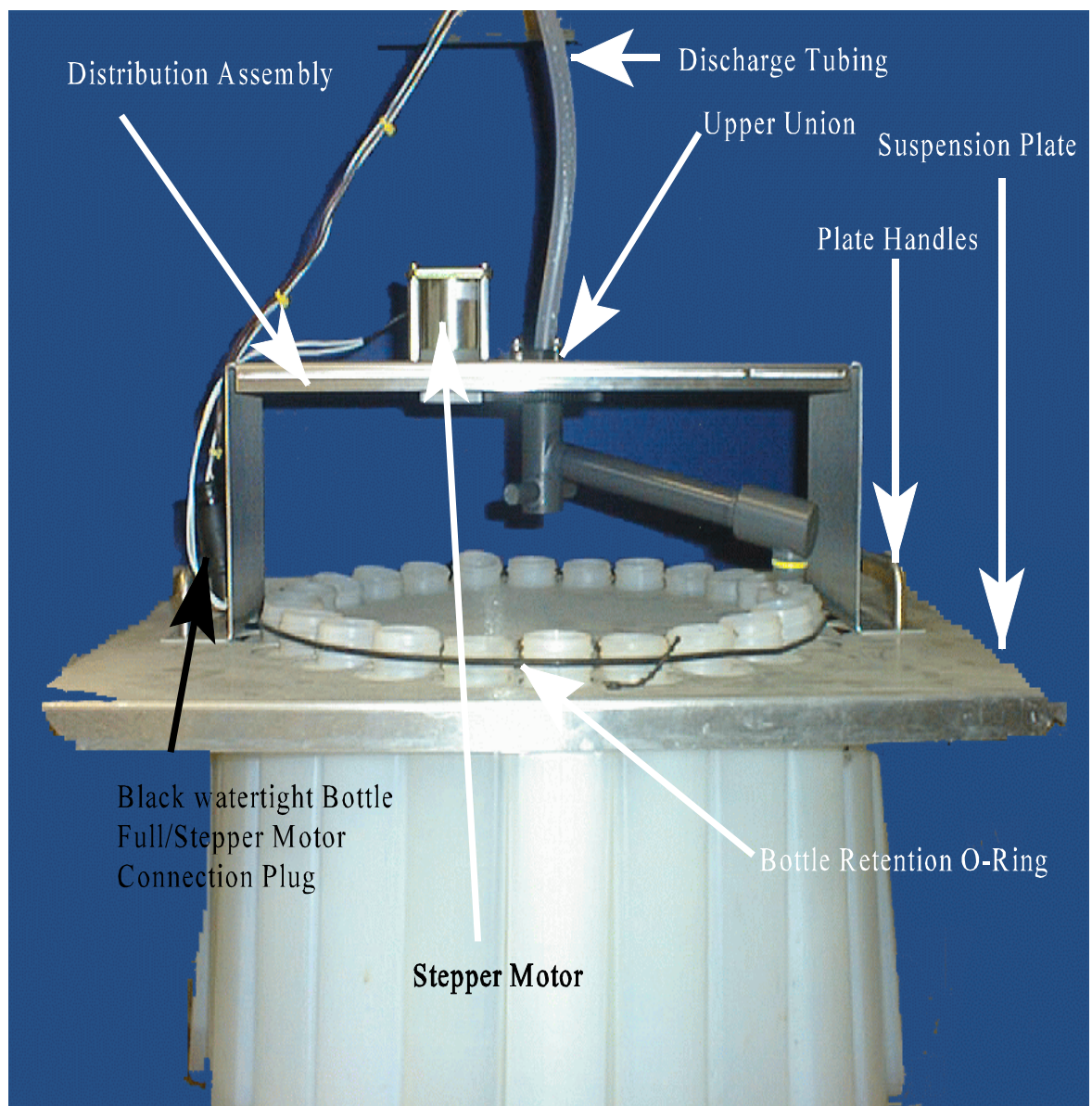

Figure 16 - Distribution Assembly Picture

THIS PAGE INTENTIONALLY BLANK

Bottle Installation

The bottles can be installed with the suspension plate in the refrigerator, or the plate can be removed, the bottles installed, and the plate positioned back in the refrigerator.

Follow the instructions below for the type of bottles being installed.

One Liter and Half-Liter Plastic Bottles

1. Insert the bottles through the larger part of the hole in the suspension plate.
2. Place the bottles so the smaller angled part of the bottles points in toward the middle of the case. Snap each bottle into place in the smaller part of the hole. Be sure the bottles are held below the threaded section.
3. Secure bottles by placing the o-ring around them



Figure 21 - 1 liter (left) and 500ml (right) bottles

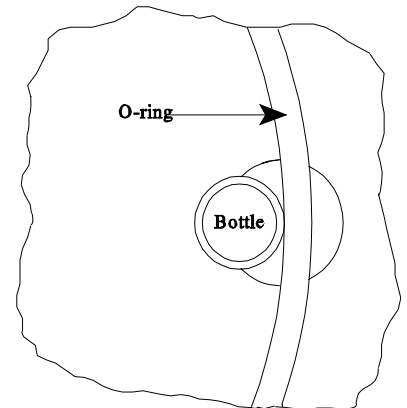

Figure 20 - 1 Liter and 1/2 Liter Bottles Installed in Suspension Plate

Spout Position

If the suspension plate was removed from the refrigerator, replace it. Place the spout over the last bottle in the series, since the first action of the sampling cycle is a spout advance.

Installing The Sampler

Install the sampler on a firm, level surface adjacent to the sampling point. If the sampler is installed outdoors, consider enclosing it in a shelter or under some sort of protection. This will improve the performance and life of the unit. The Manning Parts Department can supply an optional full-size NEMA 3R insulated fiberglass enclosure designed for this purpose.

Connecting Power

The YB8 sampler was designed with components which operate on 12 VDC power. Recognizing that 115 VAC power has to be available to run the refrigerator, the sampler takes advantage of the constant supply by employing an AC/DC converter to provide power to the system. The converter is located inside the electronics enclosure. It comes equipped with a power cord, but it can be hard wired if desired. A power switch, which controls flow of current to the controller and peristaltic

pump, is located on the front of the electronics enclosure. The refrigerator has its own individual power cord. By using the AC/DC converter the user does not have to be concerned with replacement of batteries, charging of batteries, or any other factors which affect 12 VDC systems. The system has been thoroughly tested using 115 VAC and will provide outstanding service, reliability, and longevity. To power the unit up follow these simple steps:

1. Check to make sure that the pump cover is securely fastened to the pump housing and that the unit is ready to be powered up.
2. Locate the power plug coming out of the electronics enclosure.
3. Plug the AC/DC converter into the appropriate receptacle.
4. Turn the power switch, located on the right side of the electronics enclosure, to "ON". Verify, by looking at the display, that power is being applied to the system. If the display does not light up, confirm that the appropriate connections have been made. If the unit does still not power up, call the Manning Service Department. They will be able to provide assistance in getting the unit operational.

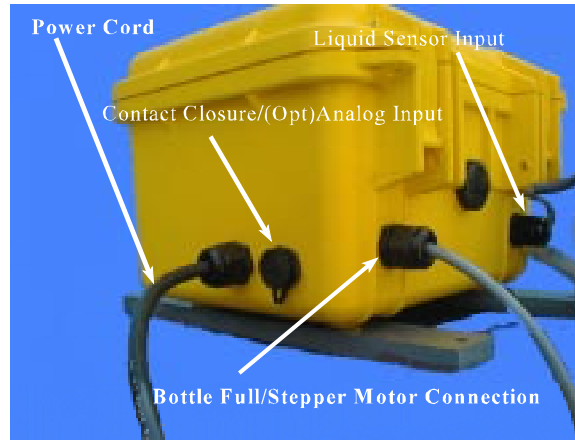

WARNING: Hard-wiring should only be done by a certified electrician.

Sample Intake Line

Attach the intake hose to the connector at the end of the pump tubing.

Intake Hose Placement

Place the intake hose strainer directly in the channel flow, not in an eddy or at the edge of the flow. In channels with debris, provide deflection to prevent clogging of strainer holes. The weight supplied with the intake hose is usually sufficient to prevent the intake from being pulled to the surface of a fast channel.

The correct vertical position of the strainer depends on the type of sample being taken. Placing the strainer at the bottom of the flow results in a heavier concentration of solids in the sample, while placing the strainer at or near the top of the flow results in heavier concentration of oils, fats, and other floating or suspended contaminants.

The intake hose should be positioned so the hose can drain between sample cycles and no low spots exist which would trap water. The correct and incorrect hose placements are shown below.

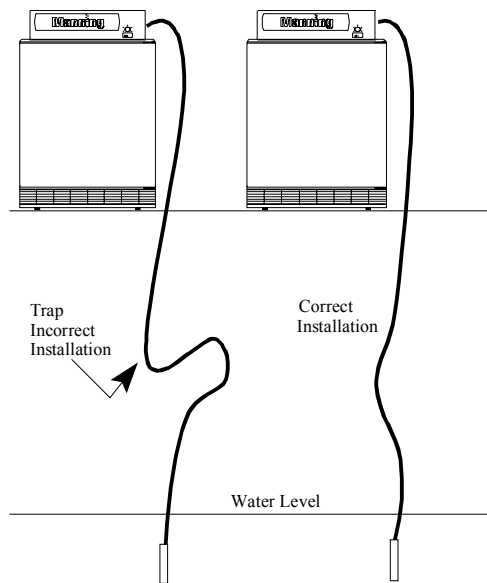

Figure 24 - Intake Hose Placement

Running A Test Cycle

While it is not mandatory to run a test cycle, it is recommended to assure proper operation and to become familiar with the various functions and modes of operation. Run a test cycle before programming any operational modes into the sampler.

1. Turn the main power switch to the “ON” position. The display should read “Sampler Ready”.
2. If the multiple bottle option is being used, rotate the spout so it is over a bottle.
3. Submerge the strainer of the intake hose in a container of clean water. The amount of water should be enough to keep the strainer covered completely for several test cycles.
4. Press the TEST CYCLE key on the keypad to initiate the test cycle. You will be prompted for the number of samples you want to take. Enter the number and press <ENTER>.

The Sampling Cycle

Refer to the errata (pages 9-11) at the end of this manual for sampler theory of operation.

There are two types of sample events. The first is time-based. In this type a time interval is defined and the sampler places a sample in each bottle based on that time interval.

The second type of sample event is flow-based. In this type an external flowmeter provides one of two types of signals: a contact closure when a specified amount of liquid has flowed past the measurement point; with the analog option, an analog signal proportional to flow rate.

Whether the sample event is triggered by a flowmeter or by a time interval, the actual sampling cycle is the same. For the multiple bottle option, the first action is the advance of the spout to the next bottle. (For single bottle samplers, this step is omitted.) Next, the sampler turns on the peristaltic pump. The pump begins rotating counter-clockwise causing air to be forced out of the intake tubing. This clears the intake hose of any contents or obstructions that may inhibit proper sample collection. After the set amount of purge time has elapsed, the unit will then reverse the pump so that the rollers are now moving in a clockwise direction. This causes vacuum to be created in the tube, which causes the source liquid, to begin traveling up the intake line. If the unit was programmed to rinse, as the source liquid rises in the intake line it will reach the liquid sensor. The sampler will immediately recognize that fluid has reached the inlet to the pump. It will instantaneously reverse the direction of the pump (rollers will be moving in a counter-clockwise rotation), sending the water that had been drawn up back out of the intake line. This in effect rinses the line. If the unit was not set for a rinse the above steps will be omitted. Upon completion of the last rinse, source liquid will again be drawn up the intake line. The system monitors the flow of liquid and when the preset amount has passed through, the pump will reverse operation again (rollers moving counter-clockwise). This purges excess fluid out of the pump and clears the intake line. Depending on how the unit is programmed or configured, after completing the post sample purge, the sampler will now stop operation or continue performing those functions which it has been programmed. For a complete description of programming the sampler see the programming section in this manual.

If the multiple bottle option is being used, the distribution spout remains stationary until the next sample event. This delay prevents cross-contamination of the next sample.

Sample Recovery

Immediate sample recovery is not required since the sampler will automatically shut down when the sample container is full (single bottle only), a pre-set number of samples have been taken, or when the program is complete. However, sample analysis may require quick recovery to maintain sample freshness or to add chemicals.

If the intent is to leave the containers in the suspension plate, caps can be installed over the suspension collars. Remove the suspension plate (with bottles) from the refrigerator. Lift the distribution assembly off the suspension plate and place it on the wire racks mounted in the refrigerator.

It may be easier to remove the distribution assembly first, and then install the bottle caps. To seal the 350ml glass bottles, replace cap liners, then place caps on bottles.

External Connections

Refer to the errata (page 3) for more information on connecting to an external device.

DANGER: Turn the sampler off at the power switch and unplug the power supply before making connections. Injury can result if the power is present when making connections.

The following chart describes the external connections which are necessary to operate the sampler:

Contact In & Analog In Connections			
Purpose	Connector Designation	Color	Polarity
Contact In	A	Red	No Polarity
Contact In	B	Black	No Polarity
Analog In (+)	D	White	Positive
Analog In (-)	C	Green	Negative

Bottle Full/Stepper Motor

The Model YB8 can utilize both a Bottle Full Sensor and Stepper Motor (not at the same time). Connections for the Bottle Full Sensor and the Stepper Motor are hardwired to the unit. If the unit was purchased as a single bottle unit only, the wires for multiple bottle operation are not run. If multiple bottle operation is desired, a conversion of the unit to multiple bottle operation will need to be done at the factory. To connect them follow the instructions listed below:

- A) Locate the cable coming out of the bulk head fitting on the left front of the electronics enclosure. It runs down through the top of the refrigerator. For single bottle units, there are two female contacts on the end. For multi-bottle units, there is a black connector.

B) Connect either the bottle full sensor or the stepper motor to the cable.

NOTE: If this connection is not made, neither the Bottle Full Sensor nor the Stepper Motor will function.

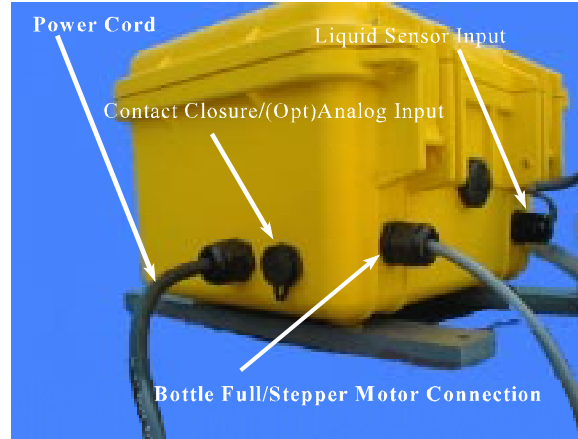

Figure 25 - Electronics Enclosure

Contact Closure

This enables the sampler to accept a contact closure from, an external device. The parameter to be measured is set, recorded, and totaled by the external device. When the set limit is met, a contact closure will be sent to the sampler. This in turn will initiate the sample collection process.

The sample comes standard with a 3 foot cable for connecting to external devices.

To connect the external device to the sampler follow the steps listed below:

- A) Locate the connector on the left side of the electronics enclosure. If the sampler has the Analog Option, it will be labeled Contact In/Analog In.
- B) Wire the red and black wires to the external device's contact closure output.
- C) Re-connect the cable to the connector on the enclosure.



Figure 27 - Contact In/Analog In Cable

This should complete the installation of the contact closure. Test the connection by initiating a closure through the external device to verify the wiring is correct and the sampler is initiating a sampling cycle when a closure is received.

Analog Signal (Optional)

With this option, the sampler can accept an external 4-20mA signal from an external device. The flow volume is internally totaled by the sampler's controller. The analog option is not available as a field retrofit. Contact the Manning Parts Department to discuss a factory modification. To connect the external device to the sampler follow the steps listed below:

- A) Locate the connector on the left side of electronics enclosure which is labeled "Contact/Analog In".

- B) Wire the white (+) and green (-) wires to the external device's analog output.
- C) Re-connect the cable to the "Contact/Analog In" connector.

This should complete the installation of the contact closure. Test the connection through the external device to verify the wiring is correct and the sampler is initiating a sampling cycle when the signal is received. See the *08 Mode in the Programming section for additional information.

This completes the installation of the sampler. The unit should now be operational. Proceed to the programming instructions to program the sampler for operation.

Programming

Section Contents

Introduction.....	Page B-1
Sampler Configuration.....	Page B-1
Sampling Modes	Page B-1
Multi-Bottle Sampling Modes	Page B-1
Single Bottle Modes.....	Page B-1
<RESET>.....	Page B-2
<TEST CYCLE>	Page B-2
<BOTTLE ADV>.....	Page B-2
<CLEAR>.....	Page B-2
<CLOCK>	Page B-2
<DISPLAY>	Page B-2
*.....	Page B-2
EEEE.....	Page B-2
Key Not Active	Page B-2
Display Information	Page B-3
Time of Day	Page B-3
Program Status	Page B-3
Sampler Ready	Page B-3
Programming.....	Page B-3
Active Program	Page B-3
Sampler Configuration Functions	Page B-4
*99 Sampler Set-Up.....	Page B-4
*20 Volume Calibration.....	Page B-7
*19 Pump Utilities	Page B-9
*91 Data Logging	Page B-11
ID Menu	Page B-12
View Menu.....	Page B-12
Exit Menu.....	Page B-16
Download Menu.....	Page B-16
Clear Menu.....	Page B-18
*14 Clear Log Data.....	Page B-18
Analog Option Programming.....	Page B-19
Totalizing	Page B-19
*08 Analog Display Routine.....	Page B-20
Add-On Programming Functions.....	Page B-22

Multiple Bottles per Sampling Event.....	Page B-22
Multiple Samples per Bottle	Page B-22
Delay Start - Time.....	Page B-24
*15 - Active Sampling	Page B-24-A
General Programs.....	Page B-25
Time Mode - *START.....	Page B-25
Time Mode - Single Time Interval	Page B-26
Flow Mode.....	Page B-28
Flow Mode - Pulse Accumulation	Page B-29
Multi-Bottle Sampling Programs.....	Page B-30
*01 Flow Mode - Independently Time Spout Advance.....	Page B-30
*02 Flow Mode - Time Interval Override.....	Page B-31
*03 Flow Mode - External Event.....	Page B-32
*04 Time Mode - Multiple Intervals.....	Page B-33
*07 Flow Mode - Time Delay Interval	Page B-35
Analog Sampling Programs	Page B-36
*05 Flow Mode - Totalizing Analog	Page B-36
*06 Analog Level Mode	Page B-38
*09 Hydrologic Level Event Mode.....	Page B-41
Multi-Bottle Flow Composite Programs.....	Page B-45
*10 Flow Mode - Multiple Bottle Composite.....	Page B-45
*11 Flow Mode - Totalizing Analog Multiple Bottle Composite.....	Page B-47
*12 Flow Mode - Multiple Bottle Composite with Bottle Groups	Page B-49
*13 Flow Mode- Totalizing Analog Multiple Bottle Composite with Bottle Groups.....	Page B-52

Introduction

The sampler is controlled by a microprocessor that can execute a wide variety of time and flow sampling sequences called Modes. Entries are made through a keypad with prompts displayed on a 2 line by 20 character backlighted LCD (Liquid Crystal Display).

Sampler Configuration

For the sampler to function properly, it must be set-up for the specific application in which it will be used. The *99 Function configures the sampler. Configuration defines multiple variables that do not usually change between different applications. These are such things as the type of sampler (single bottle, multiple bottle, or storm water), the number of bottles, and other factors like draw time, and purge time. Instructions for configuration of the sampler begin on page 2-5.

Sampling Modes

The sampler has two basic Modes: Time and Flow. (NOTE: While referred to as Flow Mode, the sampler can actuate based on signals from any external device. What device or why the device is supplying the closure is transparent to the sampler. The sampler simply registers a contact closure, so actuation can occur based on pH, ORP, Level, Flow, or other parameters. Time mode is based on a preset time period that must pass before a sample is taken. Flow mode has two variants. The standard controller (contact closure option) allows sampling based on contact closures from an external device. The analog controller (4-20mA option) allows sampling based on an analog signal totalized by the sampler's controller. All programs (or Modes) available for the Model YB8 are based on either Time or Flow. Instructions for programming the different Modes begin on page 2-14.

Multi-Bottle Sampling Modes

All of the programs or Modes can be used with multiple bottle samplers.

Single Bottle Modes

All General Programs (Basic Time and Flow Modes)

- *02 Time Interval Override Mode
- *04 Multiple Time Intervals Mode
- *05 Totalizing Analog Flow Mode
- *06 Totalizing Analog Level Mode

Utility & Display Functions

Key	Function
<RESET>	Functions as a Reset (a soft boot in computer terms) for the sampler and clears the current program mode.
<TEST CYCLE>	Allows the user to check the sampler for mechanical operation by taking a physical sample.
<BOTTLE ADV>	Advances the spout clockwise 1 bottle each time the key is pressed. This function will not work when a program is running.
<CLEAR>	Clears invalid and incorrect entries before <ENTER> has been pressed. Also allows the user to step the cursor back 1 movement, clearing entries each time the key is pressed.
<CLOCK>	Sets the time and date. To set, press RESET twice, press CLOCK, enter the time and date and then press <ENTER>. NOTE: <u>All times are entered and displayed in 24 hour HH:MM format. For example, 6 hours would be entered as 0600 and a real time of 3:30 p.m. would be displayed as 15:30.</u>
<DISPLAY>	Shows current program or configuration information. The information displayed depends on whether the user is in or out of a programmed mode. If the user is out of a programmed mode, pressing <DISPLAY> will show the configuration settings input in *99. If the user is in a programmed mode (e.g. a TIME, FLOW, or * Mode), pressing <DISPLAY> will show the current time, spout position, and other information specific to the current mode. NOTE: <u>See Appendix B for a Logic Map of the Programming Modes and what displays are active when the Display key is pressed.</u>
*	Used to program Star Modes.
EEEE	Indicates an error condition has occurred. Press CLEAR to reset, and re-enter the data.
Key Not Active	Indicates the key pressed is not active at the current time.

Display Information

The Manning sampler is capable of displaying a wealth of information through the 2 line by 20 character display. The following describes the functions and how they can be of benefit to the user:

- Time of Day The time of day is always displayed in the bottom right hand corner of the display. The format is a 24 hour clock HH:MM:SS. If the display is not counting down the seconds, the controller may have quit functioning. Press <RESET> to warm boot the system. If this does not clear the problem, please call Manning at 1-800-863-9337.

- Program Status The bottom left hand corner of the display is used for indicating miscellaneous program and functional information. The information displayed here varies depending on the operational status of the active program. The following highlights the function of the display in different modes:

 - Sampler Ready Shows time of day in HH:MM format (24 hour clock)
 - Programming In programming situations, the display is used for entering the data required by the particular mode that is being programmed.
 - Active Program The information displayed depends on the type of program and the status of that program. When a time is shown in this section of the display it is signified by a flashing colon. The time shown may signify time to sample, time override, purge time, draw time, or other times associated with the program. All time displays are in HH:MM format, except for configuration function times (draw time, purge time, measure time, deposit time) and *07 DELAYED SAMPLE EVENT MODE which are shown in MM:SS format. Non time displays are characterized by a 4 digit display which does not possess a flashing cursor. The information relayed here may be the sample number or the bottle number depending on the active program and its state.

Sampler Configuration Functions

There are 3 major configuration functions the user must be concerned with (*99, *20, & *19). Step-by-step programming instructions and descriptions of each function are detailed on the pages that follow :

*99 Sampler Set-Up

*99 allows the user to set the sampler's configuration. For proper operation, it is critical the unit is correctly configured. The memory comes preset with the sampler's defaults. These defaults can be reviewed or changed by entering the configuration mode (explanations and step-by-step instructions are given below). Once entries have been made in *99, re-entering the configuration mode is not necessary unless changes in the data are needed.

Display on LCD	Explanation
SAMPLER READY 04/30 04:30:02	This display shows the sampler is ready to program. It displays the current time. From here the user can enter any TIME, FLOW, or * Mode. Press the * key to access the * Mode.
ENTER * MODE? _ _ _	Prompts the user to enter either a program or the configuration function. Press 99 and <ENTER> to configure the sampler.
SAMPLER SETTING? _	Sets the sampler to a specific type of operation or bottle configuration: 1 = Single Bottle 2 = Multi-Bottle Other numbers are not valid and will cause the sampler to malfunction. Enter the desired configuration and press <ENTER>
# OF BOTTLES? _ _ _	Sets the number of bottles (1,2,3,4,6,8,12, or 24) in the sampler. If 1 was selected for the SAMPLER SETTING above, this prompt is bypassed. Input the number of bottles and press <ENTER>.
SAMPLE VOLUME? _ _ _ _ _	Sets the sample volume (in milliliters), to be collected per sample.
TUBE LENGTH? _ _ _ _ _	Records the length (1 to 99 feet) of the sample intake tube.
DRAW HEIGHT? _ _ _ _ _	Sets the draw height or lift height (1 to 25 feet) of the sampler.

RINSES PER SAMPLE?
— — — — **04:30:02**

Sets the number of rinses (0-3) the sampler will perform per sample cycle.

BOT VOLUME, LITERS
— — — — **04:30:02**

This tells the sampler the volume of the current container you have in the system. The volume is set in terms of full liters. So an entry of 00.50 would be 500ml or 1/2 liter. An entry of 15.00 would be 15 liters. This is used in conjunction with the number of samples to be taken so that overflow of the bottle(s) does not occur. For reference the following is a chart with gallons and the equivalent liters:

6 Gallons = 23.05 Liters	5 Gallons = 19.20 Liters
4 Gallons = 15.36 Liters	3 Gallons = 11.52 Liters
2.5 Gallons = 9.60 Liters	1 Gallon = 3.84 Liters

PURGE TIME?
— — **04:30:02**

Length of time (3-99 secs) the intake line is purged before a sample is taken. Press <ENTER> to accept the default purge time or input a new 2-digit number. If air bubbles are not coming out of the intake line, or if fluid is visible in the line after the purge has been completed, increase the purge time.

DRAW TIME?
— — — **04:30:02**

Time window (4-150 secs) during which a sample is drawn. Press <ENTER> to accept the displayed draw time or input a new draw time as a 3-digit number and then press <ENTER>. If the sample fluid does not reach the liquid sensor, increase the draw time.

AUTO RESTART?
— **04:30:02**

Sets the auto restart mode: 0 - No auto restart; 1 - auto restart activated. This option will restart the sampler and continue the program that was running, if power fails. It stores parameters, ensures orderly shutdown, and stores enough energy to complete any stepper motor steps in progress.

TEST CYCLE MODE?
— **04:30:02**

Sets the test cycle mode. Press <ENTER> to accept the default or input a new number corresponding to the manner in which test samples are to be taken:

- 0 - Only when the sampler is not running a program.
- 1 - In a program, but the sample does not count in the program.
- 2 - In a program, and the sample counts in the program.

BACKLIGHT MODE?

—

04:30:02

Sets whether the display backlights:

- 0 - Backlight is never on. This is good if power conservation is critical.
- 1 - Backlight comes on when a key is pressed. The light will automatically turn off after 30 seconds if another key is not pressed.
- 2- Backlight comes on when a key is pressed and also at the start of a sampling cycle. The light will automatically turn off after 30 seconds if another key is not pressed or another sampling cycle is not initiated.
- 3- Backlight is always on. This choice will quickly run down a battery.

ENTER PASSWORD

— — — —

04:30:02

Creates a password to stop unauthorized access. There are 2 options:

- A. Press <ENTER> to accept no password - 0000 (default shown)
- B. Enter a 4-digit number at the prompt and press <ENTER>. The user will be prompted to verify the password. Enter the same 4 digits and press <ENTER>. This sets the password. **RECORD** the numbers. To change a password, enter *99 mode and input the 4 digit numeric password at the PASSWORD PROTECTION prompt. Press <ENTER>. The user can now go into *99 and at the ENTER PASSWORD prompt, create a new password.

Note: Use a TEST CYCLE setting of 0 if TEST CYCLE is to be password protected while a program is running.

If the password is forgotten, call the Manning Service Department at (800)-863-9337.

After finishing the Configuration Mode, the sampler will return to the Sampler Ready prompt and the current time will be displayed. Configuration is now complete, and the sampler is ready for programming.

*20 Volume Calibration

*20 calibrates the unit. Calibration is critical to ensure the sampler is drawing the correct amount of sample fluid each cycle. Failure to calibrate the unit could lead to potentially inaccurate sample volumes that can adversely affect the accuracy of the analysis. The YB8 should be calibrated any time parameters that could affect the performance and accuracy of the unit are changed. This includes changing the pump tubing, varying the intake hose length, changing the sampling location, etc. To run the calibration follow the detailed instructions below. There are a few important items to remember about the *20 Mode:

- 1) A device to measure liquid volume is required. Direct the discharge side of the pump tubing into the liquid measurement container so the sample will be collected with no spillage. Measure the sample as accurately as possible as the sampler will only be as accurate as the sample volume entered into the system.
- 2) It is best to calibrate the unit at the site where sampling is to take place. This ensures that site parameters, which can affect the accuracy of the sample volume, are accounted for by the unit. If this is not possible, simulate the conditions as closely as possible, before putting the unit into service.

After entering the *20 Mode, the system will prompt the user to start the calibration cycle. After pressing <START> the unit will automatically perform the functions necessary to collect a sample. Make sure the discharge hose is directed into a measuring container. Once the unit has deposited the sample, measure it very precisely, and then enter the volume into the system at the CALIBRATION VOLUME prompt. If the sample size is correct the calibration is complete. If it is not re-run the calibration entering the amount of liquid collected into the system each time until the volume is correct. If the unit is not able to match the desired preset volume, check the *99 Mode to verify parameters that could affect the accuracy of the sample volume are entered correctly (i.e., Draw Height, Intake Hose Length, etc.). If they are confirmed accurate, call the Manning Service Department for assistance. The unit will return to the SAMPLER READY prompt after calibration.

Display on LCD	Explanation
<p>SAMPLER READY 04/30 04:30:02</p>	This display shows the sampler is ready to program. It displays the current time. From here the user can enter any TIME, FLOW, or * Mode. Press the * key to access the * Mode.
<p>ENTER * MODE? _ _ 04:30:02</p>	Prompts the user to enter either a program or the calibration function. Press 20 and <ENTER> to calibrate the sampler.
<p>SAMPLE VOLUME? 0200 04:30:02</p>	Enter the desired sample volume. The default is 200mL.

-START- TO CALIBRATE?
— — **04:30:02**

Press <START> to begin the calibration sequence. The unit will purge the line to clear it of any obstructions and to remove residual fluid. It will then begin drawing the sample. Make sure to have the discharge side of the pump tubing directed into a measuring container. The sample will be deposited, and the unit will again purge the line. Measure the sample as precisely as possible.

CALIBRATION VOLUME?
— — — — **04:30:02**

The sampler will now prompt the user to enter the amount of liquid collected in the container. If the amount of volume is correct the calibration is complete. Press <ENTER> ,
If the amount collected is not correct, enter the collected amount and re-run the calibration sequence. The sampler uses this information to adjust itself to draw the correct amount. If after running the calibration several times, and the sample volume is still not correct, check the *99 Mode to verify parameters that could affect the accuracy of the sample volume are entered correctly (i.e., Draw Height, Intake Hose Length, etc.). If they are confirmed accurate, call the Manning Service Department for assistance. The unit will return to the SAMPLER READY prompt after calibration.

*19 Pump Tube Utilities

*19 resets the tube life pump count. A peristaltic units ability to operate and perform to specifications, such as transport velocity and lift height is, to a certain extent, determined by the medical grade silicone rubber pump tubing used in the system. The characteristics of the tubing change as it wears. It becomes less resilient, less able to maintain its shape, develops pinch points on the outside edge of the tube, and as such is not capable of the performance it had when it was new. To maintain optimum performance, it is necessary to monitor the wear on the tube. *19 does this by enabling the operator to set a maximum number of pump revolutions, the tube currently in use, will be allowed to withstand. This, in effect, determines the tube's useful life. Manning recommends not exceeding 1,000,000 pump counts for a singular tube as, by this time, there is risk that the tubing could fail causing a variety of problems. *19 should be used every time the pump tubing is changed. The user will be alerted to change the tubing, when the tubing reaches the number of counts set. The warning will appear, every time the user executes a Program Mode, by pressing <START>. Since all programs are initiated by pressing <START> the warning will always appear, if appropriate, before the program is initiated. This allows the user the opportunity to exit the program and change the tubing. Once the tubing is changed, the user can re-enter the program and begin sampling.

When the pump tubing is to be changed, the user will enter into *19 Mode, just like entering any of the other * Modes. The sampler will prompt the operator to clear the current pump count by pressing 1, or to maintain the current count by pressing 0. It is advisable to reset the pump counts when changing the tubing so an accurate accounting of the number of revolutions, the tube in the pump has experienced, can be obtained. At this juncture the user will be asked to enter a number for the tube life warning which represents the number of revolutions the current tube will be allowed to accumulate before a warning is issued. Once entered, the system will return to the sampler ready prompt and the system will be ready to program.

Display on LCD	Explanation
<p>SAMPLER READY 04/30 04:30:02</p>	<p>This display shows the sampler is ready to program. It displays the current time. From here the user can enter any TIME, FLOW, or * Mode. Press the * key to access the * Mode.</p>
<p>ENTER * MODE? _ _ 04:30:02</p>	<p>Prompts the user to enter either a program or a * Mode. Press 19 and <ENTER> to proceed.</p>

0=MAINTAIN 1=CLEAR
— **04:30:02**

This prompt is asking the user to determine how the system will handle the current accumulation of revolutions:

- 0 - Maintains the current revolution count. This is useful if the operator wishes to increase the number of revolutions the current tubing can accumulate before a tube life warning is issued. For example, assume the current tubing has 200,000 revolutions. The operator really wants the warning to come on at 400,000. The 0 key would be pressed instead of 1 to maintain the history the tubing has already generated. The user would then enter 0400 (for 400,000) at the TUBE LIFE WARNING prompt (see below).
- 1 - Resets the current revolution count. This is necessary if the user is going to be placing brand new tubing into the system. With the counter reset the user knows exactly how many counts it will take for the sampler to issue a warning to change the tubing.

TUBE LIFE WARNING?
— — — — **04:30:02**

Enter the maximum number of counts the tubing will accept before the sampler issues a pump tube warning. The number entered is in terms of thousands (in other words it adds 3 0's to the end of the number entered) so if 0500 is entered, the sampler would see it as 500,000. Entering 4000 equals 4,000,000 and 0060 would be 60,000, etc. The sampler will then issue a tube life warning when the pump revolutions meet or exceed the set number of pump counts entered in *19.

*91 Data Logging

* 91 is the data logging function for the Manning Environmental Inc. sampler family. The data logging function is always active, and will continuously record events and sampler activities as they occur. The system performs a bound checking function on entries. This ensures that entries which exceed the limits placed in the system are not accepted. If this happens a EEEE will appear on the display. The user simply presses <CLEAR> to remove the EEEE and is then able to continue to enter numbers. The unit holds up to 512 entries in battery backed RAM, so in case of power loss the unit will not lose recorded events. If a 513th entry occurs, the unit will display a LOG FULL message and that entry and subsequent events and activities will not be recorded until the log is cleared. The unit will display the collected information upon the 2 line by 20 character backlighted LCD display. The data is displayed in a coded format so the maximum amount of information is available on the screen. The codes are explained in the view menu. *91 can only be entered from the SAMPLER READY prompt. The user can reach this screen from any location by pressing <RESET> <RESET>.

Display on LCD	Explanation
<p>SAMPLER READY 04/30 04:30:02</p>	<p>This display shows the sampler is ready to program. It displays the current time. From here the user can enter any TIME, FLOW, or * Mode. Press the * key to access the * Mode.</p>
<p>ENTER * MODE? _ _ 04:30:02</p>	<p>Prompts the user to enter either a program or the configuration function. Press 91 and <ENTER> to view the data logging menu.</p>
<p>ID=1 VIEW=2 EXIT=3 DOWNLOAD=4 CLEAR=5</p>	<p>This menu shows the options available in the data logging menu. It is displayed momentarily (3 seconds) before the selection menu is brought up.</p> <p>ID Menu -Allows the user to set Site ID information. VIEW Menu - Allows the user to review logged data. EXIT Menu - Takes the user out of the Data logging menu and back to the Sampler Ready prompt by executing a warm start. DOWN LOAD Menu - Downloads data to a printer, DTU, or PC. CLEAR Menu - Clears all logged data, except Site ID, from memory.</p>
<p>ENTER MENU SELECTION _ _ 04:30:02</p>	<p>Enter the number coinciding with menu to be accessed and press <ENTER>. The following sections will explain each of the sub-menus:</p>

ID Menu

The ID menu allows the user to identify a site at which the events have been logged and a corresponding date associated with the events at that site. This is represented by a 4 digit number which the user enters in the ID Menu (see below). The system only allows for one site ID at a time. For example, the user enters 1234 as a site ID number and logs 100 samples at that site. Later the sampler was moved to a different site. If the operator enters a new site ID number (5678), the original site ID (1234) will be overwritten with the new site ID number (5678). The operator should download the data before changing site ID numbers in this scenario.

ENTER MENU SELECTION
 _ _ _ _ **04:30:02**

At this prompt input a 1 and press <ENTER>

ENTER 4 DIGIT ID #
 _ _ _ _ _ **04:30:02**

The user enters a 4 digit number that corresponds to the site at which the samples will be taken. Only one site number can be used at a time. Entering a new site number, overwrites all stored site numbers.

ENTER MONTH MM#
 _ _ _ **04:30:02**

This display asks the user to enter the current month in 2 digit format. For example 03 = March, 11 = November, etc...

ENTER DAY DD #
 _ _ _ **04:30:02**

The user enters the 2 digit number corresponding to the current day. The first day of the month being 01, the last being 30 or 31.

ENTER YEAR YYYY #
 _ _ _ _ **04:30:02**

The operator enters the current year in 4 digit format.

View Menu

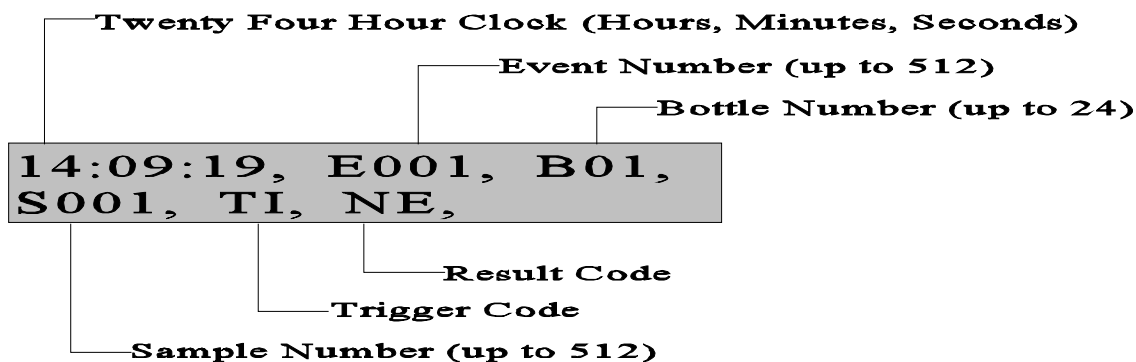

The view menu allows the user to review logged events and activities. The information recorded is not limited to sampling events. Activities such as power failure, warm starts, cold starts, etc.. are also recorded to allow the operator a fuller and more comprehensive understanding of the activities of the unit. The information in

the VIEW menu is shown in coded format to allow the maximum amount of information to be displayed in the smallest amount of space.

- TIME Twenty four hour clock in HH:MM:SS format.
- EVENT # An "E" marks the beginning of information related to Event # and is separated from the Time by a comma. The event number represents the sequential order of the events that have been logged since the operator last pushed <START>. For example E001 would be the first logged event with E512 being the last since the unit logs a maximum of 512.
- BOTTLE # Preceded by a "B", the Bottle # is separated from the Event # by a comma. Bottle number indicates the Bottle that the sample was placed into.
- SAMPLE # This is the first entry on the 2nd line of the display. It is indicated by an "S".
- TRIGGER CODES The trigger code shows the operator what triggered or initiated the sample to be taken. The following shows the letter corresponding to the sample trigger:
 - TI = Time Interval
 - TO = Time Override
 - CC = Contact Closure
 - AL = Analog Level
 - AF = Analog Flow
 - RD = Rising Delta
 - FD = Falling Delta
 - TC = Test Cycle (In a program mode)
 - TY = Test Cycle (Not in a program mode)

RESULT CODES The result code indicates whether the unit was successful or unsuccessful in collecting the sample. If the sampler was successful, the unit will indicate this with a NE. If the unit did not collect the sample either a BF or NF will be displayed. The codes are as follows:

- NE = No Error
- NF = No Fluid
- BF = Bottle Full

ACTIVITY LOG The unit also logs information about non sampling events such as power failures, start sequences, reset occurrences, etc.. This data is displayed in a different format than the event entries. You are simply shown the time, in twenty four hour format, and the activity (in this example START):

```
16:04:44, START
```

Each time the particular activity is executed (in this case START), the information will be stored in the log. This also applies to reset's, power failures, etc... The storage of this information increases the users ability to understand the sampling events and how other activities might have effected the sampling program.

DATE STAMP

The sampler possesses the ability to date stamp events that are logged. This stamping occurs in 3 instances:

- A. When a program is started
- B. When <RESET> <RESET> is executed
- C. When midnight occurs

The purpose of the date stamp is to allow the operator to know when various events occur and when they happen. The sampler does not log the date with every sample, instead when midnight occurs the date is stamped and each subsequent event, until the next occurrence of midnight, are recorded on that date.

ENTER MENU SELECTION
__ __ **04:30:02**

At this prompt input a 2 and press <ENTER>

OF EVENTS = __ __ __
 04:30:02

Shows the operator the number of events recorded. The sampler holds a total of 512 events. This is a momentary display (3 seconds).

ENTER THE START #
 04:30:02

The operator is then prompted to enter the point (event #) at which they want to begin the display of recorded events. Input the starting point as a 3 digit number and press <ENTER>

ENTER THE COUNT #
__ __ __ **04:30:02**

The user is then prompted to enter the number of events they wish to view. Input the number of events to be viewed as a 3 digit number and press <ENTER>. This feature allows the user to view all the logged events, a section of the logged events (300 to 400 for example), or a single event.

<p>ENTER SCROLL SECONDS ____ 04:30:02</p>
--

To set the scroll seconds, enter a 2 digit number representing the amount of time, in seconds, you wish the display to show a recorded event before advancing to the next screen. After inputting press <ENTER>

The sampler displays recorded events in one of two ways:

A. By entering the scroll seconds, the sampler automatically advances sequentially through the recorded events, showing each event for the set number of scroll seconds. This will continue until the event entered in the COUNT # is displayed. The sampler will then return to the ENTER SELECTION prompt within *91.

B. The user can also manually review the logged events, although scroll seconds still have to be entered. To manually examine the logged events press <DISPLAY> once for each event to be reviewed. If <DISPLAY> is not pressed, the unit will default and use the entered scroll time to advance the display.

<p>PUSH THE DISPLAY KEY FOR NEXT EVENT</p>

This is a momentary display (3 seconds) to remind the user that they can manually advance the log review or that the unit will do it automatically based on the time set at the scroll seconds prompt.

<p>__:__:__, E____, B__ S____, __, __</p>
--

This display is divided into multiple sections to communicate information about the logged sample.

1st line

- 1st section - Time at which the sample was collected.
- 2nd section - Headed by a capital "E", indicates the event number.
- 3rd section - Headed by a capital "B" represents the bottle number.

2nd line

- 1st section - Headed by a capital "S" indicates the sample number.
- 2nd section - Trigger Codes - This is a 2 letter code that specifies what initiated the sample. For a complete list of codes, refer to page 11 - TRIGGER CODES.
- 3rd section - The last section signifies result code. This tells the user whether the sampler was successful or unsuccessful in collecting a sample and why.

To quit viewing data, simply press <RESET> once. This takes you to the beginning of the menu selection in the Data Logging menu. The unit will continue to show the events either based on the scroll time or by pressing <DISPLAY> until the STOP # is reached. At this point the unit will return the operator to the ENTER SELECTION prompt.

Exit Menu

This menu allows the user to exit back to the SAMPLER READY prompt from which other programs or functions can be entered. The only other way to exit the data logging menus is to press <RESET>. However, this will be recorded as an activity, whereas using the exit menu will not.

ENTER MENU SELECTION
 _ _ _ 04:30:02

At this prompt input a 3 and press <ENTER>. The unit will execute a warm start and return to the SAMPLER READY prompt.

Download Menu

The download menu is intended to allow the operator to make either a hard copy (by sending the information to a printer) or an electronic copy (by sending the information to a PC or a Data Transfer Unit). The information is in ASCII format and is comma delimited for easier interface with commercially available spreadsheet programs. The Baud Rate is fixed at 9600 with 8 bits no parity and 1 stop bit. The download menu is identical to the VIEW menu. The only difference is that when the data is reviewed, it is also being downloaded to the device of choice.

ENTER MENU SELECTION
 _ _ _ 04:30:02

At this prompt input a 4 and press <ENTER>

OF EVENTS = _ _ _
 04:30:02

Shows the operator the number of events recorded. The sampler holds a total of 512 events. This is a momentary display (3 seconds).

ENTER THE START #
 04:30:02

The operator is then prompted to enter the point (event #) at which they want to begin the display of recorded events. Input the starting point as a 3 digit number and press <ENTER>

ENTER THE COUNT #
 _ _ _ 04:30:02

The user is then prompted to enter the number of events they wish to view. Input the number of events to be viewed as a 3 digit number and press <ENTER>. This feature allows the user to view all the logged events, a section of the logged events (300 to 400 for example), or a single event.

ENTER SCROLL SECONDS
 ____ **04:30:02**

To set the scroll seconds, enter a 2 digit number representing the amount of time, in seconds, you wish the display to show a recorded event before advancing to the next screen. After inputting press <ENTER>

The sampler displays recorded events in one of two ways:

A. By entering the scroll seconds, the sampler automatically advances sequentially through the recorded events, showing each event for the set number of scroll seconds. This will continue until the event entered in the COUNT # is displayed. The sampler will then return to the ENTER SELECTION prompt within *91.

B. The user can also manually review the logged events, although scroll seconds still have to be entered. To manually examine the logged events press <DISPLAY> once for each event to be reviewed. If <DISPLAY> is not pressed, the unit will default and use the entered scroll time to advance the display.

**PUSH THE DISPLAY
 KEY FOR NEXT EVENT**

This is a momentary display (3 seconds) to remind the user that they can manually advance the log review or that the unit will do it automatically based on the time set at the scroll seconds prompt.

__:__:__, E____, B__
 S____, __, __

This display is divided into multiple sections to communicate information about the logged sample.

1st line

- 1st section - Time at which the sample was collected.
- 2nd section - Headed by a capital "E", indicates the event number.
- 3rd section - Headed by a capital "B" represents the bottle number.

2nd line

- 1st section - Headed by a capital "S" indicates the sample number.
- 2nd section - Trigger Codes - This is a 2 letter code that specifies what initiated the sample. For a complete list of codes, refer to page 11 - TRIGGER CODES.
- 3rd section - The last section signifies result code. This tells the user whether the sampler was successful or unsuccessful in collecting a sample and why.

The unit will begin to scroll through the entries one at a time either based on the default or on the user pressing the <DISPLAY> key. The information being displayed is also being sent to the data collection device attached to the sampler (i.e. printer, PC, DTU).

Clear Menu

The sampler is capable of holding up to 512 events or activities in memory. Once the databank is filled, the unit will not store any additional information until the event log is cleared. Once the log has been cleared the information that had been stored there is permanently erased. If the information is critical please review the DOWNLOAD menu above for information on how to save the logged events and activities in either electronic format or hard copy.

ENTER MENU SELECTION
— — 04:30:02

At this prompt input a 5 and press <ENTER>

CLEAR LOG DATA
NO = 1 YES = 2 04:30:02

This display is shown momentarily to orient the user to the upcoming menu selection.

CLEAR?? NO = 1 YES = 2
04:30:02

Enter your selection at the prompt:

- 1 This does not clear the data and will take you back to the ENTER SELECTION prompt.
- 2 This will clear all data. If there is any data that needs to be retained, make sure a backup exists. Once the data has been deleted it is unrecoverable. After the data is cleared, you will be taken back to the ENTER SELECTION prompt.

*14 Clear Log Data

* 14 Clear Log Data option allows the operator to clear the logged data without entering the *91 data logging program. This selection does not give the user the opportunity to back-out of the clearing of the log. This is an immediate and unalterable erasure. The *14 clear data unlike the *91 clear data is accessible from the SAMPLER READY prompt

SAMPLER READY
04/30 04:30:02

This display shows the sampler is ready to program. It displays the current time. From here the user can enter any TIME, FLOW, or * Mode. Press the * key to access the * Mode.

ENTER * MODE?
— — 04:30:02

Prompts the user to enter either a program or the configuration function. Press 14 and <ENTER> to erase the logged data.

CLEARING LOG DATA

The menu shows the log being cleared. The log is now clear. The data that was contained within the log is now erased and is unrecoverable.

SAMPLER READY
04/30 04:30:02

The unit returns to the SAMPLER READY prompt awaiting further action.

Analog Option Programming

This section explains how to program the sampler if the unit has the optional analog controller. If it was not ordered, it is not necessary to read this section. The analog option allows the sampler to accept an analog signal (4-20mA) from an external device.

When using any of the analog programming Modes (*05,*06, *09, *11, and *13), the sampler will prompt the user to enter an upper and a lower limit. These limits can refer to flow or level depending on the program. The limits are important because of the Analog to Digital converter in the YB8. The converter allows an analog signal to be divided into 256 (0 to 255) divisions which digitizes the signal. The lower limit will correspond to the lowest signal level (4mA in 4-20mA, etc.) sent from the external device. The higher limit will correspond to the highest signal level (4-20mA) sent from the external device. The difference between the lower limit and the higher limit is the span. The processor divides the span into 256 evenly spaced steps.

For example, with a 4-20mA signal, if you set the lower limit to equal 4 ft and the upper limit to equal 44 feet the following values would automatically be assigned to each:

Analog Signal	Level	A/D Digital Value
4mA	4ft.	0
8mA	14ft.	63
12mA	24ft.	127
16mA	34ft.	180
20mA	44ft.	255

Totalizing

When the volts or amps of a signal vary, corresponding to a flow, then the signal can be used to totalize the flow. Each time the analog signal is read, a value is obtained that can be converted into a flow. For example, (using a 4-20mA signal) when the analog signal is 12mA, then we know that the flow rate is half of the total. If maximum flow is 100 and minimum is 0, then the flow rate is 50. The volume units of the number are determined by the volume units of the maximum and minimum flows. If they are in liter then the flow is in liters, if they are in gallons then the flow is in gallons. Flow is volume per unit time, and though the volume unit can be anything the time units cannot. Except for 1 condition the flow unit should be volume unit per minute (gallon/min, L/min, etc), and the interval to check the analog signal should be 1 minute. The exception is when the sampling sequence (time to take and deposit a sample) takes longer than 1 minute. In this case, the time interval between analog signal checks must be increased. When the time interval between analog signal checks is greater then 1 minute, the volume that triggers a sample must be divided by the value of the time interval to function properly.

*08 Analog Display Routine

The analog display routine allows the operator to display the analog signal received from an external meter (level, flow pH, etc.). This routine can be used while the sampler is being installed, connected to a flow meter, or to check the calibration of the sampler's analog to digital converter.

The program is started by entering <*08> at the "SAMPLER READY" prompt. The analog value will be displayed in three formats: 1) As a digital value (0 to 255); 2) As a DC voltage (1 to 5 VDC); and 3) in milliamps (4.0 to 20.0 mA). The program will continue to loop until reset by the operator pressing the <RESET> key twice. The analog input signal can be varied while the program is running and the display will change accordingly.

The sampler's analog routine can be calibrated by inputting a known milliamp signal or attaching a variable voltage source across the analog input terminals.

ANALOG VALUES TABLE
TABLE A1

mA	DC VOLTS	DIGITAL VALUE
4.0	1.00	000
5.0	1.25	015
6.0	1.50	031
7.0	1.75	047
8.0	2.00	063
9.0	2.25	079
10	2.50	095
11	2.75	111
12	3.00	127
13	3.25	143
14	3.50	159
15	3.75	175
16	4.00	191
17	4.25	207
18	4.50	223
19	4.75	239
20	5.00	255

Table A1 is a conversion table for the analog values. For example, if a voltage of 3.00 volts is placed across the analog input terminals the sampler should display 12 mA, 3.00 VDS and a digital value of 127. The analog input circuit is designed with a precision 250 ohm resistor across the input terminals. When an mA analog signal is input the current flows through the 250 ohm resistor generating a voltage drop proportional to the current flow. At 12 mA the voltage drop is $.012 \times 250 = 3.00$ volts. The three volts is converted into a digital value 127. When a three volt signal is placed across the analog input terminals it generates a current flow according to ohms law of $I = 3/250 = .012$ mA.

Constant current sources are not common. However, batteries of known voltages are readily available; thus, using a voltage source to calibrate the sampler is useful.

A 4-20 mA source can be calibrated by placing a 250 ohm resistor in the loop and measuring the voltage drop across the resistor with a voltmeter. Table A1 can be used to interpolate the corresponding MA signal or Ohms law ($V/R = I$) can be used to calculate the mA signal. If the voltage is 4.25, then the mA signal is $4.25/250 = .017$ amps or 17 mA.

Add-On Programming Functions

Multiple Bottles per Sampling Event

Multiple Bottles per Sampling Event is not a stand alone function but works in conjunction with TIME, FLOW and certain * Modes (*02, *04, *05, *06, *09) to expand the capabilities of the sampler. This option places 1 sample in from 2-24 bottles in rapid succession during 1 sampling event (such as a contact closure or a time interval). To use Multiple Bottle per Sampling Event, the user selects the mode of choice - a TIME, FLOW, or * Mode. After entering the required information, the PUSH START/OPTIONS prompt will appear on the display. At this cue press <MULTI BOTTLE> and enter the number of bottles into which 1 sample should be placed, in rapid succession. For example, Multiple Bottles per Sampling Event would be used if a sample is to be taken every 100,000 gallons, and 1 sample is to be placed in 5 different bottles each time there is a contact closure. The unit would start the sampling sequence after it had received a contact closure. It would draw and place 1 sample in the first bottle, immediately move to the second, draw and place 1 sample in that bottle, immediately move to the third, draw and place 1 sample in that bottle and so on until it had deposited 1 sample in the specified number of bottles (in this example 5).

Display on LCD	Explanation
SAMPLER READY 04/30 04:30:02	This display indicates the sampler is ready to program. Multiple Bottles per Sampling Event is not a stand alone program. It works in conjunction with FLOW, TIME, and certain * Modes. In this example <FLOW> was pushed as the mode of choice.
PUSH START/OPTIONS 04:30:02	At this prompt the user selects Multiple Bottles per Sampling Event, by pressing <MULTI BOTTLE>.
BOTTLES PER SAMPLE? _ _ _ 04:30:02	Input the number of bottles into which 1 sample will be placed in rapid succession during a sampling event and press <ENTER>.
PUSH START/OPTIONS 04:30:02	At this point, simply press <START>. <u>NOTE: Multiple Bottles per Sampling Event and Multiple Samples per Bottle cannot be selected simultaneously. They are mutually exclusive options.</u>
FLOW MODE _ _ _ _ _ 04:30:02	The unit is now waiting for a contact closure to initiate the sample sequence.

Multiple Samples per Bottle

Multiple Samples per Bottle is not a stand alone function but works in conjunction with other TIME, FLOW and certain * Modes (*02, *04, *05, *06, *09) to expand the capabilities of the sampler. The sampler places from 2 to 99 samples in each bottle. In order to use Multiple Samples per Bottle, the user selects the mode of choice - a TIME, FLOW, or * Mode. After entering the required information, the PUSH START/OPTIONS prompt will appear on the display. At this cue press <MULTI SAMPLE> and enter the number of samples per bottle. For example, if Flow Mode were being used and Multiple Samples Per Bottle is set at 5, each time an event occurred, such as a contact closure or the end of a time interval, the sampler would place a sample in a bottle. When the next event occurs, the sampler would place another sample in the SAME bottle, until 5 samples had been placed in that bottle. It would then advance the spout to the next bottle in sequence. The sampler would then repeat the process above for the current bottle. This would continue until the total number of bottles the unit is configured for (set in *99) have received their allocation of samples.

Display on LCD	Explanation
<p>SAMPLER READY 04/30 04:30:02</p>	This display indicates the sampler is ready to program. Multiple Samples per Bottle is not a stand alone program. It works in conjunction with FLOW, TIME and certain * Modes. In this example <FLOW> was pushed as the mode of choice.
<p>PUSH START/OPTIONS 04:30:02</p>	At this prompt the user selects Multiple Samples per Bottle, by pressing <MULTI SAMPLE>.
<p>SAMPLES PER BOTTLE? — — 04:30:02</p>	Input the number of bottles into which 1 sample will be placed during a sampling event and press <ENTER>.
<p>PUSH START/OPTIONS 04:30:02</p>	At this point, simply press <START>. <u>NOTE: Multiple Bottles per Sampling Event and Multiple Samples per Bottle cannot be selected simultaneously. They are mutually exclusive options.</u>
<p>FLOW MODE — — — — 04:30:02</p>	The unit is now waiting for a contact closure to initiate the sample sequence.

Delay Start - Time

Delay Start - Time works in conjunction with TIME and certain * Modes to expand the capabilities of the sampler. It is not a stand alone program and cannot be used with * Start, FLOW MODES, *01, *05, *06, *09, *11, *12, or *13. Delay Start - Time works by allowing the user to add a period of time to the beginning of a TIME or * Mode to delay the start of the program. This time period must elapse before the program can begin to operate. **NOTE:** Some programs already have a Delay Start - Time in the program negating the user's ability to add an additional Delay Start - Time. The user selects the mode of choice and enters the required information. The PUSH START/OPTIONS prompt will then appear on the display. At this cue press <DELAY START> and enter the amount of time (in HH:MM format) the sampler is to wait before beginning the program. Once the Delay Start has elapsed, the program will start. For example, if the sampler were programmed with a 9.5 hour Delay Start - Time and a 1.5 hour Time Interval, the sampler would wait for 11 hours until the first sample is taken, (9.5 hours of Delay Start - Time and 1.5 hours for the Time Interval). The sampler would then take a sample every 1.5 hours until all of the bottles (set in *99) each have a sample placed in them or a bottle full condition occurs.

Display on LCD

Explanation

<p>SAMPLER READY 04/30 04:30:02</p>	<p>This display indicates the sampler is ready to program. Delay Start - Time is not a stand alone program. It works in conjunction with TIME, and certain * Modes. In this example <TIME> was pushed as the mode of choice.</p>
<p>ENTER INTERVAL TIME __ : __ 04:30:02</p>	<p>Enter the time interval as a 4-digit number (HH:MM format) and then press <ENTER>.</p>
<p>PUSH START/OPTIONS 04:30:02</p>	<p>The program can then be started by pressing <START> or other functions can be added on such as Delay Start - Time. In this example <DELAY START> was pressed.</p>
<p>ENTER DELAY START __ : __ 04:30:02</p>	<p>This display prompts the user to enter a Delay Start time (in HH:MM format). This is the amount of time the sampler is to wait before starting the regular program (in this case TIME mode).</p>
<p>PUSH START/OPTIONS 04:30:02</p>	<p>The sampler is now ready to begin operation. Press <START> to begin the Delay Start countdown, or add other options such as Multiple Samples per Bottle or Multiple Bottles per Sampling Event.</p>
<p>DELAY START TIME __ : __ 04:30:02</p>	<p>This display shows the time remaining on the Delay Start.</p>
<p>TIME TO NEXT SAMPLE __ : __ 04:30:02</p>	<p>Once the Delay Start has counted down to zero, the Interval Time entered earlier will begin counting down. This display shows the time left to take a sample. As mentioned above, Delay Start - Time works with TIME, and certain * Modes.</p>

*15 - Active Sampling

This mode allows the operator to program active sampling periods for each day of the week. The operator enters the days to sample and an active time period (start time to stop time) for each day that sampling is to occur. The operator also chooses if the sampler will restart sampling (clears program parameters) or resume sampling (keep the program parameters from the last active period) when a new active day and time is started. In order for Active Sampling (*15) to work correctly, the sampler clock must be correctly set, and a sampling program (TIME, FLOW, *02, *05) must be programmed.

If an end of sequence event (such as a bottle full) occurs before the active sampling period expires, then the active time period will have no effect. If the active time period expires while a sample is in process the sample will be completed and no more samples will be taken. After active sampling is set up in Program 15, the operator then programs the sampler with whatever time or flow-paced program is required. During the active time period of an active day of the week, the sampler collect samples based on the sample program that is running. At the end of the active time period no more samples are collected until the next active day/time period.

If Active Sampling is programmed, The right-most position (position 20) on the top line of the LCD display indicates the Active Sampling status. A blinking "A" indicates that the sampler is in an active time period and sampling is allowed. A blinking "I" indicates that the sample is in a inactive time period and no sampling is allowed. If the last active period of the week has passed, the second line of the display indicated "NO MORE", meaning that no more sampling will occur that week. A week starts on Monday and ends on Sunday. Active sampling is turned turn off by entering the Program 15 mode and entering a 0 at the ACTIVE SAMPLING? prompt.

The major use of the active sampling period will be in industrial monitoring situations where (as dictated by the EPA) a valid sample period cannot be longer than a specified period of time (i.e., 24 hours), or in sampling situations where sampling is only required for a certain part of the week (i.e., Thursday 8:00AM until Sunday 8:00PM).

Display on LCD	Explanation
SAMPLER READY 04/30 04:30:02	This display indicates the sampler is ready to program and alternately displays the current time and date. Press the * key to begin programming.
ENTER PROGRAM # — — 07/30FRI	The sampler is now prompting for a star mode to be input. Enter the numbers which represent the star mode of choice, in this example 15, and press <ENTER>.
ACTIVE SAMPLING? 0 04:30:02	The sampler then asks if Active Sampling is to be turned on. Enter a "1" and press <ENTER> . To turn off Active Sampling, enter a "0" and press <ENTER>. If Active Sampling is turned off, the display will return to the SAMPLER READY prompt.

RESTART=0 RESUME=1
0 04:30:02

The sampler then prompts for selection of RESTARTING sampling at the beginning of each active period (enter "0") or RESUMING sampling at the beginning of each active period (enter "1"). Restarting sampling causes the sampler reset the bottle and sample count at the beginning of the next active period.

ENTER DAYS OF WEEK
Mo Tu We Th Fr Sa Su

The display prompts to enter the days of the week that you want to sample. This information is displayed for only 5 seconds.

1 2 3 4 5 6 7

The display then changes to numbers on the bottom line which represent the days of the week (1=Monday, 2=Tuesday, etc.) Press number key(s) on the keypad that corresponds to the day(s) that you want to sample.

Mo Tu Fr
1 2 3 4 5 6 7

For each day that was selected as a active sampling day, the name of the day will appear above its corresponding number on the first line of the display. If you press the number key of a day that is active, it will become inactive and the name of the day will disappear from the first line of the display. After all the active days have been selected, press <ENTER> to continue.

Mon. START TIME
__:__ 04:30:50

For each day that was selected as an active sampling day, the sampler asks for a start time in HH:MM format. Enter the start time and press <ENTER>. Enter a start time of 00:00 if you want sampling to start at the beginning of the day.

Mon. STOP TIME
__:__ 07/30FRI

The sampler then asks for the stop time in HH:MM format. Enter the stop and press <ENTER>. Enter a stop time of 24:00 if you want sampling to continue to the end of the day.

This step and the previous one are repeated for each day that was selected to be an active sampling day.

SAMPLER READY A
04:30:02

After the final stop time has been entered, the display will change to SAMPLER READY. If the present day and time is in an active sampling period, the display will have a blinking "A" in the upper right-hand corner. If the present day and time is not in an active sampling period, the display will have a blinking "I" in the upper right-hand corner.

Once the active period has been setup using Program 15, you can then enter a sampling program.

General Programs

Time Mode - * Start

* START is a unique programming mode. It is unlike any other mode in that it automatically programs the unit to take a sample every hour. Simply press the * key and then <START>. As soon as <START> is pressed, the sampler begins counting down 1 hour. At the end of that hour the sample sequence will be initiated. The sampler will advance the spout, draw 1 sample, and place it in a bottle. The time interval will reset as soon as the sample cycle starts. At the end of the second hour the spout will advance and another sample will be taken and deposited. This will continue until the total number of bottles the unit is configured for (set in *99) each have 1 sample placed in them or a bottle full condition occurs. The sequence will then be finished and the unit will stop operation waiting for the same or a new program to be entered. For example, if the sampler was configured for 24 bottles, the sampler would place 1 sample in each bottle, over a 24 hour period for a total of 24 samples, and then stop operation.

Display on LCD

Explanation

SAMPLER READY 04/30 04:30:02	This display indicates the sampler is ready to program and displays the current time. Press the * key to begin programming.
ENTER * MODE — — 04:30:02	At the ENTER * MODE prompt, press <START> to begin the * Start Mode.
TIME TO NEXT SAMPLE 01:00 04:30:02	The sampler is automatically programmed and the display will show the time (in HH:MM format) until the next sample.

Time Mode - Single Time Interval

This mode is similar to * START except the user sets the Time Interval instead of having it automatically set to 1 hour. The user enters a time in HH:MM format from 1 minute to 99 hours and 59 minutes. This time interval is used to initiate each sampling sequence in this program until the sampler ends its cycle and/or is re-programmed. After the time interval is entered and the program has been initiated by pressing <START>, the sampler will begin counting down the time interval. When the interval has elapsed, the unit will advance the spout, draw 1 sample, and place it in a bottle. The timer will reset as soon as the sample cycle starts and will immediately begin counting down the same time interval again. After the interval has elapsed again, the spout will advance and another sample will be taken and deposited. This will continue until the total number of bottles the unit is configured for (set in *99) each have 1 sample placed in them or a bottle full condition occurs. For example, if the time interval is set for 1 hour 30 minutes, the sampler would count down 1 hour and 30 minutes, advance the spout, take the first sample, and reset the timer. After another 1 hour and 30 minutes the spout would advance to bottle 2, the sampler would take a sample and reset the timer, etc.

Display on LCD

Explanation

<p>SAMPLER READY 04/30 04:30:02</p>	<p>This display indicates the sampler is ready to program and displays the current time. Press <TIME> to begin programming.</p>
<p>ENTER INTERVAL TIME __ : __ 04:30:02</p>	<p>Enter the time interval as a 4-digit number (HH:MM format) and then press <ENTER>.</p>
<p>PUSH START/OPTIONS 04:30:02</p>	<p>The program can then be started by pressing <START> or other functions can be added. In this example, <START> is pressed.</p>
<p>TIME TO NEXT SAMPLE __ : __ 04:30:02</p>	<p>The display will show the time until the next sample.</p>

THIS PAGE BLANK

Flow Mode

Flow Modes differ from Time Modes in that instead of taking a sample after a time interval has elapsed, the unit will take samples after receipt of a contact closure from an external device. Whether those contact closures are based off Flow, pH, Level, ORP, DO, etc. is transparent to the sampler. The unit simply acknowledges a contact closure was received and that in turn triggers the sample collection process. In FLOW Mode the sampler does not control totalization, logging, or the meeting of certain parameters, etc. so they must be done by the external device. Once the parameters have been met, a contact closure will be output to the sampler. Every time a contact closure is received, the sample collection process is initiated. The sampler will advance the spout, draw 1 sample and place it in a bottle. It will then wait for the next contact closure while displaying a running tally indicating the number of samples taken to that point. This will continue until the total number of bottles the unit is configured for (set in *99) each have a sample placed in them or a bottle full condition occurs. If either of these two conditions occur, the sampler ends the program.

Display on LCD

Explanation

SAMPLER READY
10:04

This display indicates the sampler is ready to program and displays the current time. Press <FLOW> to begin programming.

PUSH START/OPTIONS

The program can then be started by pressing <START> or other functions can be added. In this example, <START> was pressed.

FLOW MODE
— — — —

The sampler is now waiting to accept contact closures to trigger the sample collection process.

Flow Mode - Pulse Accumulation

FLOW Mode - Pulse Accumulation operates the same as FLOW Mode except instead of taking a sample after every contact closure, a sample is taken after a set number of contact closures (from 2 - 9,999) have been accumulated. **NOTE:** This program uses <DELAY START> for setting the number of contact closures to be accumulated. The display will show the number of contact closures the sampler is programmed to accumulate before taking a sample. Every time a contact closure is received, the sampler will decrease the number needed on the display by one. This shows how many more contacts have yet to be accumulated before a sample is taken. Once the set number of contact closures are received, the sampler will advance the spout, draw 1 sample and then place it in a bottle. It will then wait for the next accumulation. This will continue until the total number of bottles the unit is configured for (set in *99) each have a sample placed in them or a bottle full condition occurs. If, either of these two conditions occur, the sampler ends the program.

Display on LCD	Explanation
SAMPLER READY 04/30 04:30:02	This display indicates the sampler is ready to program and displays the current time. Press <FLOW> to begin programming.
PUSH START/OPTIONS 04:30:02	To set the number of contacts to be accumulated in FLOW Mode - Pulse Accumulation, press <DELAY START> and then the <START> button.
DELAY IN PULSES? _ _ _ _ 04:30:02	The user is now prompted to set the number of contact closures the sampler will accumulate before taking a sample (2 - 9,999). Until it is changed or ends its cycle, it will always accumulate the same number of pulses before taking a sample.
PUSH START/OPTIONS 04:30:02	Unless add-on options to the program are desired, press <START>.
FLOW MODE _ _ _ _ 04:30:02	This display shows the number of contact closures remaining before a sample will be taken. As contact closures are received the sampler counts down until it reaches 0. It will then take a sample and reset to accumulate the entered number of contact closures again.

Multi-Bottle Sampling Programs

*01 Flow Mode - Independently Timed Spout Advance

The *01 program is used to obtain flow proportional samples over a period of time. Each bottle the sampler is configured for has a time interval (referred to as a time window) during which it is active. Samples can only be placed in THAT bottle during THAT active time window. Once the sampler is programmed, it waits for a contact closure while counting down the time interval that was set. If it receives a contact closure, while counting down the Time Interval, a sample sequence will be initiated. The sampler will advance the spout, draw 1 sample, and place it in the active bottle. For every contact closure received during the active time window, the sampler will place 1 sample in the SAME active bottle. Once the first time window has elapsed (all the time windows have the same time increment), the sampler will begin counting down the second time window while waiting for contact closures for the next active bottle. This continues until all of the bottles (set in *99) have at least 1 sample placed in them. A bottle could potentially have more than 1 sample if more than 1 contact closure is received during the bottle's active time window. If the sampler has not received a contact closure by the end of the active time window the unit will advance the bottle spout and place 1 sample in the bottle that had most recently been active.

NOTE: There is no overflow protection in this mode. Make sure that the sample volume is small enough compared to the flow rate to prevent over-filling.

Display on LCD	Explanation
SAMPLER READY 04/30 04:30:02	This display indicates the sampler is ready to program and displays the current time. Press the * key to begin programming.
ENTER * MODE — — 04:30:02	The sampler is now prompting for a star mode to be input. Enter the numbers which represent the star mode of choice, in this example 01, and press <ENTER>.
ACTIVE TIME INTERVAL — — : — — 04:30:02	The sampler then asks for an interval time. This is the amount of time (1 min to 99 hours and 59 min) during which the sampler will place samples in the active bottle. Enter the time in HH:MM format and press <ENTER>.
PUSH START/OPTIONS 04:30:02	If no add-on options are desired, press <START> to begin the program.
FLOW MODE (* 01) — — — — 04:30:02	The sampler is now waiting to receive contact closures and is independently counting down the interval time.

*02 Flow Mode - Time Interval Override

*02 operates much like basic FLOW mode except a time override is added. The override time ensures a sample is collected, after a set amount of time has elapsed, if a contact closure has not been received. Once the program has been started the sampler will immediately begin counting down the override time. The sampler is also concurrently waiting for contact closures. Every time a contact closure is detected the sampler will advance the spout, draw a sample, and then place it in a bottle. It will then wait for the next contact closure while displaying a running tally indicating the number of samples collected to that point. If there have been no contact closures by the end of the override time the user specifies, the sampler will advance the spout, draw a sample, and then place it in a bottle. The override timer will then reset and immediately start counting down again while waiting for the next contact closure. This will continue until the total number of bottles the unit is configured for (set in *99) each have their set number of samples placed in them or a bottle full condition occurs. If either of these two conditions occur, the sampler ends the program. The unit will take 1 sample per override time interval until all bottles have samples.

Display on LCD	Explanation
<p>SAMPLER READY 04/30 04:30:02</p>	This display indicates the sampler is ready to program and displays the current time. Press the * key to begin programming.
<p>ENTER * MODE _ _ _ 04:30:02</p>	The sampler is now prompting for a star mode to be input. Enter the numbers which represent the star mode of choice, in this example 02, and press <ENTER>.
<p>TIME OVERRIDE? _ _ : _ _ 04:30:02</p>	Input the maximum time the sampler will be allowed to wait to receive a contact closure, understanding that if the unit has not received a closure in this time, it will automatically take a sample. Press <ENTER> after inputting.
<p>PUSH START/OPTIONS 04:30:02</p>	If no add-on options are desired, press <START> to begin the program.
<p>FLOW MODE (* 02) _ _ _ _ 04:30:02</p>	The sampler is now ready to receive contact closures and is independently counting down the Time Override.

*03 Flow Mode - External Event

*03 is used for monitoring intermittent events by combining portions of Flow and Time modes. *03 differs from regular flow modes based on the way the sampler interacts with the contact closures it receives. In normal flow mode the sampler receives a momentary closure from an external device, and this initiates a sampling cycle. In *03 the sampler also initiates a sample cycle based off the initial contact closure it receives. Once it has received that initial closure, the contact must remain closed for *03 to operate as intended. By the contact remaining closed, the time portion of the mode is brought into effect and the unit will take samples based off a user set time interval. For example, assume the user has an external device with a relay that is normally open. The user sets a high and low trip point within the device. If an event takes place based on the high or low set point, the unit will send a closure to the sampler. This causes a sampling cycle to take place. If the contact does not remain closed, the unit will act as if it were programmed for regular flow mode, and simply take samples each time a contact closure is received. If the relay remains closed, however, the unit will then start to count down the user set time interval and once that interval has elapsed, take a sample. Each time the interval elapses, the unit will perform a sampling sequence. This will continue until the total number of bottles the unit is configured for (set in *99) each have their set number of samples placed in them or a bottle full condition occurs. If the contact opens before either of these two occurrences the sampler will suspend operation until it once again receives a contact closure that remains closed. After receiving another contact that remains closed the sampler will begin where it left off from the last contact closure.

Display on LCD	Explanation
SAMPLER READY 04/30 04:30:02	This display indicates the sampler is ready to program and displays the current time. Press the * key to begin programming.
ENTER * MODE _ _ 04:30:02	The sampler is now prompting for a star mode to be input. Enter the numbers which represent the star mode of choice, in this example 03, and press <ENTER>.
ENTER TIME INTERVAL _ _ : _ _ 04:30:02	Input a time interval in HH:MM format.
PUSH START/OPTIONS 04:30:02	If no add-on options are desired, press <START> to begin the program. NOTE: DELAY START does not work with *03.
FLOW MODE (* 03) _ _ _ _ 04:30:02	The sampler is now ready to receive contact closures and is independently counting down the Time Override.

***04 Time Mode - Multiple Intervals**

The *04 mode allows programming of up to 12 DIFFERENT non-uniform time intervals (1 min to 99 hours and 59 minutes). Non uniform time intervals refer to each interval being different from the previous or next interval. Once an interval is entered, the user is given the option of repeating the interval or entering a new interval. To repeat the interval, press <ENTER> once for each time the user wants the same interval repeated. The display will show the COUNT increasing, indicating the same interval is being logged multiple times. An interval can be the same as a previous interval as long as there is a DIFFERENT interval between them. For example if 01:00 was entered for the first interval, 02:00 for the second, and then 01:00 was entered again, this would be counted as THREE different intervals. After the program is initiated, the sampler will begin counting down the first interval. Once that interval has elapsed, the unit will start the sample taking sequence and will immediately start counting down the next interval. The sampler will draw and place a sample in 1 bottle and then advance the spout. The sampler will repeat the operation each time an interval expires. The sampler will continue this pattern until all the intervals entered have expired, the total number of bottles the unit is configured for (set in *99) each have at least 1 sample placed in them, or a bottle full condition occurs. Data entry can be ended at any time by pressing the * key.

Display on LCD	Explanation
<p>SAMPLER READY 04/30 04:30:02</p>	<p>This display indicates the sampler is ready to program and displays the current time. Press the * key to begin programming.</p>
<p>ENTER * MODE — — 04:30:02</p>	<p>The sampler is now prompting for a star mode to be input. Enter the numbers which represent the star mode of choice, in this example 04, and press <ENTER>.</p>
<p>ENTER FIRST INTERVAL — — : — — 04:30:02</p>	<p>The user is prompted to input the first time interval in HH:MM format. Once the entry is complete press <ENTER>. The sampler considers this the <u>FIRST</u> time interval.</p>
<p>INTERVAL:1 COUNT: 1 01 :00 04:30:02</p>	<p>The display is now indicating it has recorded 1 interval (up to 12 different ones can be entered) and the interval has not been repeated. In this example the user entered an interval of 1 Hour. The user must now input a new interval or repeat the current interval.</p>
<p>INTERVAL:2 COUNT: 1 02 :00 04:30:02</p>	<p>The user inputs a new interval (0200) representing 2 hours. The display indicates the new interval has been logged by showing a (2) after the interval.</p>
<p>INTERVAL:2 COUNT: 2 02 :00 04:30:02</p>	<p>The user decides to duplicate the last interval. Press <ENTER> once for each time the current interval should be repeated. THIS DOES NOT COUNT AS A NEW INTERVAL as shown by the 2 after the COUNT.</p>
<p>INTERVAL:2 COUNT: 3 02 :00 04:30:02</p>	<p>In this example, the user has pressed <ENTER> again to log another interval of the same length. This is the third interval of 2 hours.</p>

INTERVAL:3 COUNT: 1
01 : 00 04:30:02

The user has now logged a third DIFFERENT interval. Even though this is the same as Interval 1, it is considered a different interval since it is not the same as the previous interval. An interval that has been entered before can be repeated as long as there is a different interval between intervals of like time. If 12 different intervals are logged the PUSH START/OPTIONS prompt will appear. Otherwise data entry can be terminated at any point by pressing the * key.

PUSH START/OPTIONS
04:30:02

If no add-on options are desired, press <START> to begin the program.

TIME TO NEXT SAMPLE
01:00 04:30:02

The sampler displays the first time interval to be counted down.

***07 Flow Mode - Time Interval Delay**

*07 operates much like basic FLOW mode except a time interval delay is added after a contact closure has been received. Just like in FLOW mode, the sampler waits for receipt of a contact closure. Once that closure has been taken, the unit immediately begins counting down a user set time interval delay. Once the delay has counted down, the unit performs a sampling sequence. It will then wait for the next contact closure while displaying a running tally indicating the number of samples collected to that point. Upon the next closure the unit will once again count down the user set interval and then take a sample. This will continue until the total number of bottles the unit is configured for (set in *99) each have their set number of samples placed in them or a bottle full condition occurs. If either of these two conditions occur, the sampler ends the program.

Display on LCD	Explanation
<p>SAMPLER READY 04/30 04:30:02</p>	<p>This display indicates the sampler is ready to program and displays the current time. Press the * key to begin programming.</p>
<p>ENTER * MODE — — 04:30:02</p>	<p>The sampler is now prompting for a star mode to be input. Enter the numbers which represent the star mode of choice, in this example 02, and press <ENTER>.</p>
<p>TIME DELAY? ___ : ___ 04:30:02</p>	<p>Input the time the sampler is to wait, after receipt of a contact closure, to take a sample. After getting the signal the unit will count down the interval and take a sample. Press <ENTER> after input.</p>
<p>PUSH START/OPTIONS 04:30:02</p>	<p>If no add-on options are desired, press <START> to begin the program.</p>
<p>FLOW MODE (* 07) — — — — 04:30:02</p>	<p>The sampler is now ready to receive contact closures.</p>

Analog Sampling Programs

*05 Flow Mode - Totalizing Analog

The *05 mode works much like FLOW mode except instead of relying on a contact closure, the sampler integrates and totalizes an analog signal (4-20mA) from an external device which represents flow rate. For more details on how the analog controller works, refer to the analog programming section on page 2-12. Since the sampler does not ask for a definition of the volume unit of the flow rate, ANY can be used, i.e. cubic feet, liters or gallons. Once the unit is programmed, it begins reading the analog signal once per minute to internally totalize and keep track of the volume. When the totalized flow rate matches the Sample Trigger Volume entered by the user, the sample collection process is initiated. The unit will advance the spout, take a sample and deposit it in the first bottle. Every time the totalized volume matches the Sample Trigger Volume, the sampler will take a sample and deposit it, and then move to the next bottle in sequence. The sampler will continue this pattern of depositing a sample in each bottle, until the total number of bottles the unit is configured for (set in *99) each have a sample placed in them or a bottle full condition occurs.

NOTE: In order for the sampler to correctly scale the analog signal being output from the external device, the parameters (in this case maximum and minimum flow) set in the sampler and the external device must be the same. This is to ensure that if the external device is reading 100,000 gallons and outputting a 4mA signal, the sampler will also know that 100,000 gallons is equal to 4mA. If the parameters do not correspond there is a risk that the sampler will potentially not scale the analog signal correctly and will subsequently not take samples at the anticipated or correct instances.

Display on LCD	Explanation
SAMPLER READY 04/30 04:30:02	This display indicates the sampler is ready to program and displays the current time. Press the * key to begin programming.
ENTER * MODE — — 04:30:02	The sampler is now prompting for a star mode to be input. Enter the numbers which represent the star mode of choice, in this example 05, and press <ENTER>.
MAXIMUM FLOW RATE? — — — — 04:30:02	Input the 4 most significant digits of the Maximum anticipated flow rate. Since the unit of measurement is generic it can stand for any volume/unit of time. If the flow rate is 40, it could be entered as: 4000, 0400, or 0040. The decimal point is implied, in each case, so <u>be consistent with all entries.</u> Rate must be in units per minute.
MINIMUM FLOW RATE? — — — — 04:30:02	Enter the 4 most significant digits of the Minimum anticipated flow rate. The same criteria apply to this input as to Maximum Flow Rate.
FLOW MULTIPLIER? — — — — 04:30:02	The Flow Multiplier is used to scale the Maximum & Minimum Flow Rates. If the Max flow rate is 40,000, enter it as 4000 (first 4 significant digits). The user would then enter a Flow Multiplier of 10 (4000 x 10 = 40,000) to have the unit scale the flow rate as 40,000.

SAMPLE TRIGGER?
— — — — **04:30:02**

Enter the 4 most significant digits that tell the sampler at what accumulation of totalized flow a sample should be taken. Remember the decimal point is implied and must be consistent with previous entries. If the user wanted to take a sample at 150,000 units, the entry would be 1500.

TRIGGER MULTIPLIER?
— — — — **04:30:02**

The Trigger Multiplier is used to increase, if necessary, the Sample Trigger. Using the example above, if 150,000 units is the Trigger point, the Trigger Multiplier would be 100 (1500 x 100 = 150,000).

PUSH START/OPTIONS
 04:30:02

If no add-on options are desired, press <START> to begin the program.

FLOW MODE (*05)
— — — — **04:30:02**

The sampler is now waiting to take samples.

*06 Analog Level Mode

The *06 mode expands the capability of the sampler by allowing it to collect samples based on changing level parameters. The sampler is used in conjunction with an external device which outputs an analog signal (4-20mA) representing level (for more details on how the analog controller works, refer to the analog programming section on page 2-12). The sampler does not ask for a definition of this level unit, so ANY can be used, i.e. feet, meters, or inches. Once the unit is programmed and started, the sampler integrates the analog signal once per minute to internally track the water level. When the source water level rises above or falls below a Sampling Level, the sample collection process is initiated. The sampler will advance the spout, take a sample and deposit it in the first bottle. Every time a Sample Level is exceeded or passed after that, the sampler will take a sample, deposit it, and then move to the next bottle in sequence. The sampler will continue this pattern of depositing samples in each bottle until the total number of bottles the unit is configured for (set in *99) each have a sample placed in them or a bottle full condition occurs.

To use the *06 mode, the following entries must be entered:

- UPPER LEVEL LIMIT This is the highest anticipated level of the source liquid. It acts as a ceiling. If the water ever rises above the Upper Level Limit, the sampler considers the level as temporarily fixed at the highest Sampling Level (once the level falls below this point, normal program operation resumes). It is important to make sure the Upper Level Limit is high enough to prevent this from occurring.
- LOWER LEVEL LIMIT This is the lowest anticipated level of the source liquid. It acts as a floor. If it is possible for the level to drop below the Lower Level Limit, and it does, the sampler considers the level as temporarily fixed at the Lower Level Limit (once the level rises above this point, normal program operation resumes). It is important to make sure the Lower Level Limit is low enough to prevent this from occurring.
- SAMPLING LEVEL (1-32) These are the levels at which samples will be taken (up to 32 levels can be programmed). Enter the level as a 4-digit number. Remember the decimal point is implied, and must be consistent with previous ones. The unit of measure is generic so it can be feet, meters, etc. The * key will end data entry at any time if all 32 levels are not going to be entered.

The difference (delta) between the Upper Level Limit and the Lower Level Limit is called the span (or distance). In figure 2-2, the Upper Level Limit is 37 and the Lower Level Limit is 2.5, so the span is 34.5. The controller divides the span into 256 equal steps, with each step equal to 0.39% (1/256) of the total. The sampler will always display the next acceptable level. A level that is greater can be entered or the user can accept the displayed entry.

The lowest Sampling Level, must be greater than the Lower Level Limit and each successive level must be greater than the previous level. In figure 2-2, the Lower Level Limit is 2.5 and Sampling Level 1 is 4.0. The highest sampling level can be equal to the Upper Level Limit, although this is not necessary. If it is equal to the Upper Level Limit, it must be entered separately. In figure 2-2, the highest sampling level is equal to the Upper Level Limit so it is entered as Sampling Level 7. Press <START> to begin the program.

NOTE: In order for the sampler to correctly scale the analog signal being output from the external device, the parameters (in this case Upper Level Limit and Lower Level Limit) set in the sampler and the external device must be the same. This is to ensure that if the external device is reading 10 feet and outputting a 4mA signal, the sampler will also know that 10 feet is equal to 4mA. If the parameters do not correspond, there is a risk that the sampler will potentially not scale the analog signal correctly and will subsequently not take samples at the anticipated or correct instances.

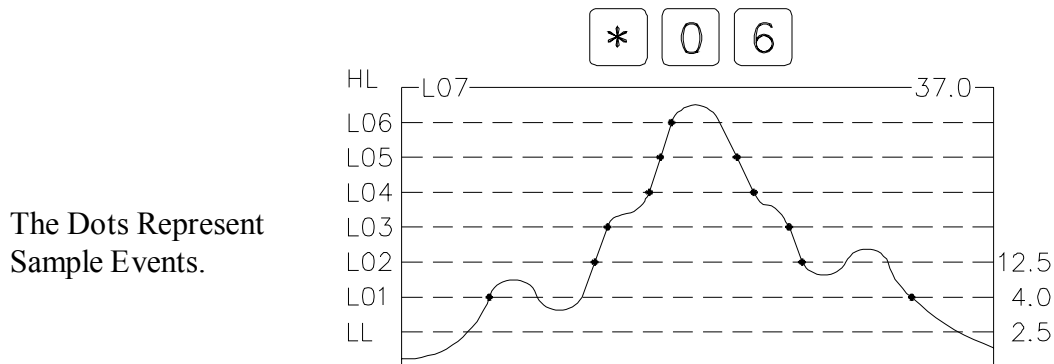

Figure 2-2 The Totalizing Analog Level Mode.

Display on LCD

Explanation

<p>SAMPLER READY 04/30 04:30:02</p>	<p>This display indicates the sampler is ready to program and displays the current time. Press the * key to begin programming.</p>
<p>ENTER * MODE — — 04:30:02</p>	<p>The sampler is now prompting for a star mode to be input. Enter the numbers which represent the star mode of choice, in this example 06, and press <ENTER>.</p>
<p>UPPER LEVEL LIMIT? — — — — 04:30:02</p>	<p>Enter the Upper Level Limit as a 4-digit number. Remember the decimal is implied in this program and the unit of measure is generic, so if the user wants 10 feet/meters/inches/millimeters, it could be entered as 0010, 0100, or 1000. Make sure to be CONSISTENT in entries throughout the program.</p>
<p>LOWER LEVEL LIMIT? — — — — 04:30:02</p>	<p>Enter the Lower Level Limit as a 4-digit number. Remember to be consistent with the implied decimal from previous entries.</p>
<p>SAMPLING LEVEL 1? — — — — 04:30:02</p>	<p>Enter the first level as a 4-digit number remembering to put in the implied decimal point. Sampling Level 1 must be greater than the Lower Level Limit.</p>

SAMPLING LEVEL 2?
— — — — — **04:30:02**

Continue to enter 4-digit numbers for Sampling Levels (up to 32 levels) remembering that each subsequent level must be greater than the proceeding one and that the decimal point is implied and must be consistent with previous entries. The user can end data entry at any point by pressing the * key.

PUSH START/OPTIONS
— — — — — **04:30:02**

If no add-on options are desired, press <START> to begin the program.

FLOW MODE (* 06)
— — — — — **04:30:02**

The sampler will immediately begin reading the analog signal.

***09 Hydrologic Level Event Mode** **(Storm Water Sampling)**

The *09 mode is used primarily for Storm Water Sampling, although it can be used to sample in any situation where there are rising and falling levels. The sampler is used in conjunction with an external device which outputs an analog signal (4-20mA) representing level (for more details on how the analog controller works, refer to the analog programming section on page 2-12). The sampler does not ask for a definition of this level so ANY can be used, i.e. feet, meters, or inches. After the unit has been programmed and started, it reads the analog signal once per minute to internally track the water level. Sampling does not begin until the source water level reaches Sampling Level 1. Once this has occurred, a sample is taken and the Time Override for Sampling Level 1 begins counting down. After Sampling Level 1 is reached, *09 Mode has 3 ways to trigger a sample:

- 1) When the analog signal corresponds to a Sampling Level.
- 2) The rise or fall of the water level by a user set amount (Rising or Falling Delta).
- 3) When the Time Override has elapsed if there has not been a large enough increase or decrease in water level or another Sampling Level has not been reached.

If any of these occur, the sampler will advance the spout, take a sample and deposit it in the first bottle. The sampler will continue this pattern of depositing samples in each bottle, until the total number of bottles the unit is configured for (set in *99) each have a sample placed in them or a bottle full condition occurs. If either of the first two triggering conditions is met (the analog signal corresponding to a Sampling Level or a Rising or Falling Delta), the Time Override is reset, and begins counting down again. A different Time Override can be set for each level entered. Each Time Override is only active in that portion or range of the total span that corresponds to its Sampling Level. Time Override 4 is active from the start of Sampling Level 4 to the beginning of Sampling Level 5.

The following entries are required. See figure 2-3 for an example.

Upper Level Limit	Maximum Analog Level (hydrologic high point) 100% of span.
Lower Level Limit	Minimum Analog level (hydrologic low point). 0% of span. The difference between the Upper Level Limit and the Lower Level Limit is the span.
Rising (positive) Delta	Rising change in water level, resulting in a sample. NOTE: <u>The user can enter only 1 Rising Delta for the duration of the program.</u>
Falling (negative) Delta	Falling change in water level, resulting in a sample. NOTE: <u>The user can enter only 1 Falling Delta for the duration of the program.</u>
Sampling Level 1	Water level at which the first sample will be taken, and which is associated with Time Override 1.
Time Override 1	Time Override to the next sample in the range. Causes a sample to be taken if the Rising or Falling Delta, or Sampling Level 2 has not been met within the override time. It will reset after a sample is taken.
Sampling Level 2-6	Subsequent higher levels at which samples will be taken.

Time Override 2-6 Subsequent Time Overrides that correspond to the equivalent Sampling Level.

The difference (delta) between the Upper Level Limit and the Lower Level Limit is called the span (or distance). In figure 2-3, the Upper Level Limit is 65 and the Lower Level Limit is 4, so the span is 61. The controller divides the span into 256 equal steps, with each step equal to .39% (1/256) of the total. If a level which is not a multiple of 1/256 is entered, the controller will indicate an acceptable entry. Up to 6 levels can be entered, however data entry can be stopped at any time by pressing the * key. After the * key is pressed, the LCD will prompt the user to either start the Program or add-on other options.

NOTE: In order for the sampler to correctly scale the analog signal being output from the external device, the parameters (in this case Upper Level Limit and Lower Level Limit) set in the sampler and the external device must be the same. This is to ensure that if the external device is reading 10 feet and outputting a 4mA signal, the sampler will also know that 10 feet is equal to 4mA. If the parameters do not correspond, there is a risk that the sampler will potentially not scale the analog signal correctly and will subsequently not take samples at the anticipated or correct instances.

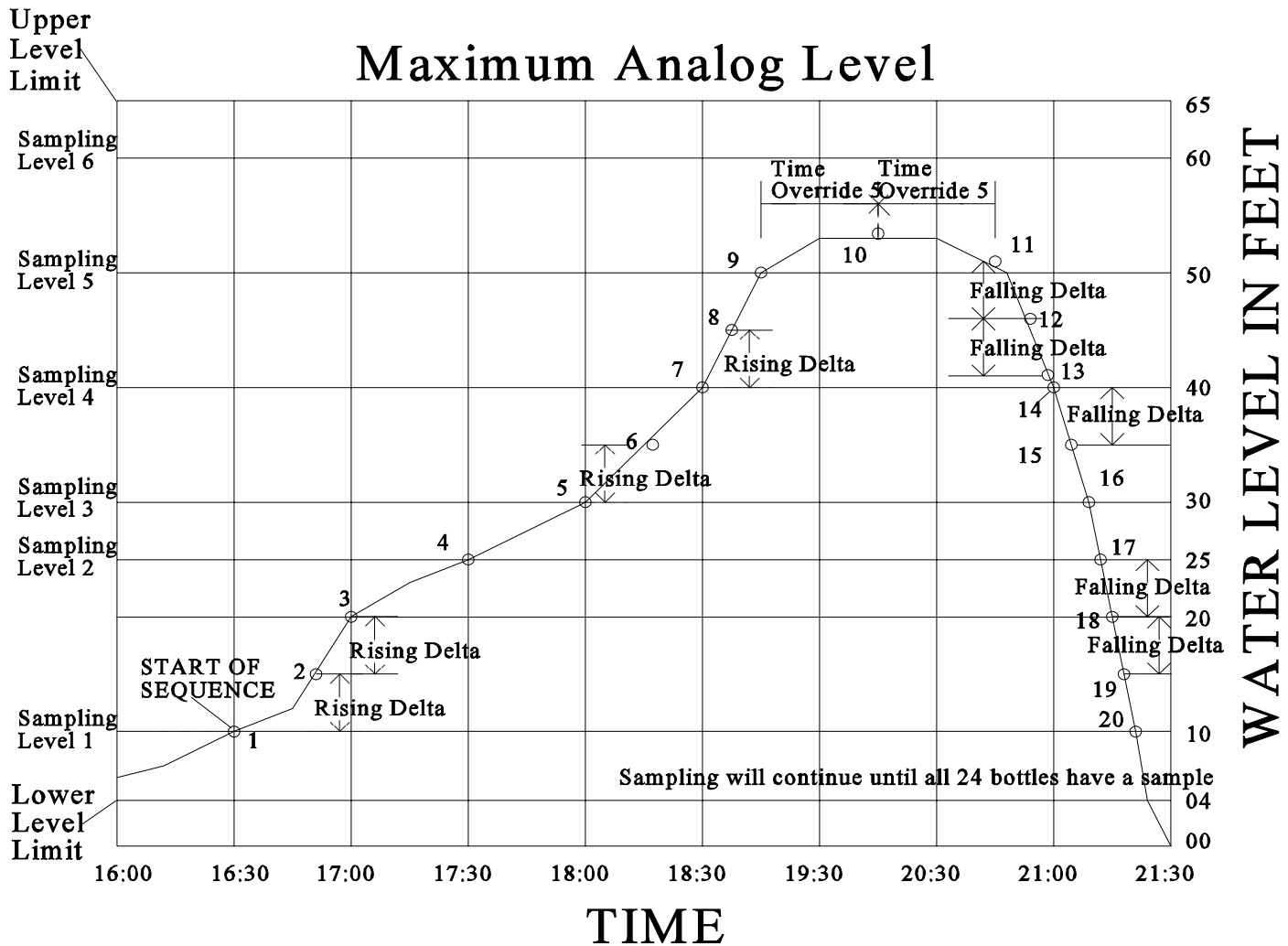

Figure 2-3 The *09 Storm Water Sampling Mode

Display on LCD	Explanation
SAMPLER READY 04/30 04:30:02	This display indicates the sampler is ready to program and displays the current time. Press the * key to begin programming.
ENTER * MODE — — 04:30:02	The sampler is now prompting for a star mode to be input. Enter the numbers which represent the star mode of choice, in this example 09, and press <ENTER>.
UPPER LEVEL LIMIT? — — — — 04:30:02	Enter the Upper Level Limit as a 4-digit number. Remember the decimal is implied in this program and the unit of measure is generic, so if the entry were to be 10 feet/meters/inches/millimeters, it could be entered as 0010, 0100, or 1000. Be CONSISTENT in all entries throughout the program.
LOWER LEVEL LIMIT? — — — — 04:30:02	Enter the Lower Level Limit as a 4-digit number. Remember to be consistent with the implied decimal from previous entries.
RISING DELTA? — — — — 04:30:02	Enter a 4-digit number which represents the <u>rising</u> change in water level that will trigger a sample to be taken. If the rise of the water is equal to or greater than this number a sample will be taken.
FALLING DELTA? — — — — 04:30:02	Enter a 4-digit number which represents the <u>falling</u> change in water level that will trigger a sample to be taken. If the fall of the water is equal to or greater than this number a sample will be taken.
SAMPLING LEVEL 1? — — — — 04:30:02	Enter a 4-digit number that represents the lowest level at which a sample is to be taken. Must be greater than the Lower Level Limit. Remember to be consistent with the implied decimal from previous entries.
TIME OVERRIDE 1? — — : — — 04:30:02	Enter a time in HH:MM format. This is the amount of time after Sampling Level 1 during which the sampler waits for an event (Rising or Falling Delta, Sampling Level 2 reached, etc.). If no event occurs before the interval is done, a sample will be taken. If an event occurs, the Time Override will reset, or move to Time Override 2 if Sampling Level 2 has been reached.
SAMPLING LEVEL 2? — — — — 04:30:02	Enter a 4-digit number representing the next level at which a sample should be taken, keeping consistent with the implied decimal point in previous entries. A sample will be taken when the water level rises to this point. Must be greater than Sampling Level 1.
TIME OVERRIDE 2? — — — — 04:30:02	Enter a time in HH:MM format. Operates on the same principal as Time Override 1.

SAMPLING LEVEL 3?

04:30:02

Enter a 4-digit number. Operates the same as previous Sampling Levels.

TIME OVERRIDE 3?

04:30:02

Enter a time in HH:MM format. Operates on the same principal as Time Override 1. Continue to enter Levels and Times for up to 6 levels. Data entry can be ended at any time by pressing the * key. The last level can be equal to the Upper Level Limit but it is not necessary. If it is equal it must be entered separately.

PUSH START/OPTIONS
04:30:02

If no add-on options are desired, press <START> to begin the program.

FLOW MODE (*09)

04:30:02

The sampler will immediately begin reading the analog signal.

Multi-Bottle Flow Composite Programs

*10 Flow Mode - Multiple Bottle Composite

The *10 mode augments basic flow mode by allowing Multiple Bottles per Sample and Multiple Samples per Bottle to be used together. Normally they are mutually exclusive but *10 combines the two, using Flow with Multiple Bottles per Sample as the base. It adds Multiple Samples per Bottle by letting the user place multiple samples (1-99) in the same bottle creating a composite sample. NOTE: The number of samples should be equal to or less than the volume of the sample containers divided by the volume of the sample, to prevent over filling. The unit operates by accepting contact closures from an external device. Whether those contact closures are based off Flow, pH, Level, ORP, DO etc. is transparent to the sampler. The unit simply acknowledges a contact closure was received and that in turn triggers the sample collection process. In *10 the sampler does not control totalization, logging, or the meeting of certain parameters, etc. so they must be done by the external device. Once the parameters have been met, a contact closure will be output to the sampler. Every time a contact closure is received, the sample collection process is initiated. The unit will advance the spout, draw its samples and place them in the correct bottles. It will then wait for the next contact closure. This will continue until the total number of bottles the unit is configured for (set in *99) each have a sample placed in them or a bottle full condition occurs. If either of these two conditions are met, the sampler ends the program.

For example, assume the sampler is configured for 24 bottles and Samples per Bottle is set to 3 (see step by step programming below). The sampler, after receiving a contact closure, will in rapid succession place 1 sample in each bottle it is configured for (set in *99). In this case, since the sampler is configured for 24 bottles, a total of 24 samples would be deposited (one in each bottle). After depositing this set of samples the unit would pause awaiting the next contact closure to place the second set of samples in the bottles (there would be 48 total samples taken after the second contact closure - 2 in each bottle). After the third set, the sampler would end the sequence and wait for a new program (there would be 72 total samples taken - 3 in each bottle).

The override time causes the unit to take samples if the contact closure fails to occur. The override time starts counting down immediately after pressing <START>. If a contact closure is received, the override time resets and immediately begins to count down again. NOTE: This means that the override time must be longer than the time it takes for the sampling sequence to complete. If it is not, the override time will elapse while the sampler is in the sequence causing the sampler to immediately start another sequence after it finishes the previous one.

Display on LCD	Explanation
<div style="border: 1px solid black; padding: 5px;"> <p>SAMPLER READY 04/30 04:30:02</p> </div>	This display indicates the sampler is ready to program and displays the current time. Press the * key to begin programming.
<div style="border: 1px solid black; padding: 5px;"> <p>ENTER * MODE — — 04:30:02</p> </div>	The sampler is now prompting for a star mode to be input. Enter the numbers which represent the star mode of choice, in this example 10, and press <ENTER>.

SAMPLES PER BOTTLE?
— — **04:30:02**

Enter the number of samples per bottle as a 2-digit number (1-99).
Make sure the volume to be placed in the bottles is not greater than
the actual volume of the bottles.

TIME OVERRIDE?
— — : — — **04:30:02**

Enter in HH:MM format. Remember to allow enough time for the
sampler to collect the required samples.

PUSH START/OPTIONS
 04:30:02

If no add-on options are desired, press <START> to begin the
program.

FLOW MODE (*10)
— — — — **04:30:02**

The sampler is now ready to receive contact closures and is
independently counting down the interval time.

*11 Flow Mode - Totalizing Analog Multiple Bottle Composite

This mode is a combination of *05 (the ability to process an analog signal), and *10 (the ability to use Multiple Bottles per Sample and Multiple Samples per Bottle together). *11 works by integrating and totalizing an analog signal (4-20mA, 0-20mA, 0-1V, or 1-5V DC) from an external device that represents flow rate. For more details on how the analog controller works, refer to the analog programming section on page 2-12. Since the sampler does not ask for a definition of the volume unit of the flow rate, ANY can be used, i.e. cubic feet, liters or gallons. Once the unit is programmed, it begins reading the analog signal once per minute to internally totalize and keep track of the volume. When the totalized flow rate matches the Sample Trigger Volume entered, the sample collection process is initiated. The unit will advance the spout and in rapid succession draw and place its samples. The unit will then pause awaiting the next trigger. Every time the totalized volume matches the Sample Trigger Volume, the sampler will draw its samples, deposit them, and wait for another Sample Trigger. The sampler will continue this pattern until the total number of bottles the unit is configured for (set in *99) each have a sample placed in them or a bottle full condition occurs.

For example, assume the sampler is configured for 24 bottles and Samples per Bottle is set to 3 (see step by step programming below). The sampler, after receiving a contact closure, will in rapid succession place 1 sample in each bottle it is configured for (set in *99). In this case, since the sampler is configured for 24 bottles, a total of 24 samples would be deposited (one in each bottle). After depositing this set of samples the unit would pause awaiting the next contact closure to place the second set of samples in the bottles (there would be 48 total samples taken after the second contact closure - 2 in each bottle). After the third set, the sampler would end the sequence and wait for a new program (there would be 72 total samples taken - 3 in each bottle).

NOTE: In order for the sampler to correctly scale the analog signal being output from the external device, the parameters (in this case maximum and minimum flow) set in the sampler and the external device must be the same. This is to ensure that if the external device is reading 100,000 gallons and outputting a 4mA signal, the sampler will also know that 100,000 gallons is equal to 4mA. If the parameters do not correspond, there is a risk that the sampler will potentially not scale the analog signal correctly and will subsequently not take samples at the anticipated or correct instances.

The override time causes the unit to take samples if the Flow Trigger fails to occur. The override time starts counting down immediately after pressing <START>. If the Flow Trigger is received, the override time resets and immediately begins to count down again. NOTE: This means that the override time must be longer than the time it takes for the sampling sequence to complete. If it is not, the override time will elapse while the sampler is in the sequence causing the sampler to immediately start another sequence after it finishes the previous one. The time override fills bottles the same way as if a Flow Trigger were received. This will continue until the maximum number of samples (1-99) have been placed in the bottles (the number of samples should be equal to or less than the volume of the sample containers divided by the volume of the sample, to prevent over filling).

Display on LCD	Explanation
SAMPLER READY 04/30 04:30:02	This display indicates the sampler is ready to program and displays the current time. Press the * key to begin programming.
ENTER * MODE — — 04:30:02	The sampler is now prompting for a star mode to be input. Enter the numbers which represent the star mode of choice, in this example 11, and press <ENTER>.
MAXIMUM FLOW RATE? — — — — 04:30:02	Input the 4 most significant digits of the Maximum anticipated flow rate. Since the unit of measurement is generic it can stand for any volume/unit of time. If the flow rate is 40, it could be entered as: 4000, 0400, or 0040. The decimal point is implied, in each case, so <u>be consistent with all entries</u> . Rate must be in units per minute.
MINIMUM FLOW RATE? — — — — 04:30:02	Enter the 4 most significant digits of the Minimum anticipated flow rate. The same criteria apply to this input as to Maximum Flow Rate.
FLOW MULTIPLIER? — — — — 04:30:02	The Flow Multiplier is used to scale the Maximum & Minimum Flow Rates. If the Max flow rate is 40,000, enter it as 4000 (first 4 significant digits). The user would then enter a Flow Multiplier of 10 (4000 x 10 = 40,000) to have the unit scale the flow rate as 40,000.
SAMPLE TRIGGER? — — — — 04:30:02	Enter the 4 most significant digits of totalized flow at which a sample should be taken. Remember the decimal point is implied and must be consistent with previous entries. If the user wanted to take a sample every 150,000 units, the entry would be 1500.
TRIGGER MULTIPLIER? — — — — 04:30:02	The Trigger Multiplier scales the Sample Trigger. Using the example above, if 150,000 units is the Trigger point, the Trigger Multiplier would be 100 (1500 x 100 = 150,000).
SAMPLES PER BOTTLE? — — 04:30:02	Enter the number of samples per bottle as a 2-digit number (1-99). Make sure the volume to be placed in the bottles is not greater than the actual volume of the bottles.
TIME OVERRIDE? — — : — — 04:30:02	Enter in HH:MM format. Remember to allow enough time for the sampler to collect the required samples.
PUSH START/OPTIONS 04:30:02	If no add-on options are desired, press <START> to begin the program.
FLOW MODE (*11) — — — — 04:30:02	The sampler will immediately begin reading the analog signal.

***12 Flow Mode - Multiple Bottle Composite with Bottle Group**

The *12 mode functions almost identically to *10 mode, however, in this mode, up to 24 separate bottle groups can be created which accept composite samples. *12 is useful when it is not possible to collect samples on a regular basis, such as on a weekend or at a remote site. In this mode the user selects the number of bottle groups, how long each group is active (receives samples), the maximum number of samples a group will take, and a time override. NOTE: The number of **bottle groups** is entered, not the number of bottles in a group. After pushing <START>, the sampler immediately begins counting down the Delay Start. Once the Delay Start has finished counting down the sampler will be ready to receive an event (contact closure or time override). The finish of the Delay Start will also start the time override counting down. If the sampler receives an event, the unit will initiate the sampling sequence. There are several simultaneous actions.

- 1) The spout will advance to the first bottle in the active bottle group and begin the sampling process.
- 2) The active bottle group time will begin counting down. NOTE: Make sure the active time period allows enough time to collect all the samples required. If the active time period elapses before the Samples per Bottle has been satisfied, the unit will finish the sequence in progress and then move to the next bottle group without completing the current bottle group.
- 3) The time override will reset and begin counting down again. The override time causes the unit to take samples if a contact closure fails to occur. The override time starts counting down immediately after pressing <START>. NOTE: The override time must be longer than the time it takes for the sampling sequence to complete. If it is not, the override time will elapse while the unit is in a sampling sequence causing another sequence to begin immediately after finishing the previous one.

The first bottle group will be active and receive all samples for its active time period, up to the maximum number of samples. If the maximum is reached, the sampler will still wait out the rest of the active time before switching to the next bottle group. After the initiation of a sampling sequence, the sampler will advance to the first bottle in the group. The unit will place 1 sample in this bottle, and then advance to the next bottle in the group and deposit a sample. This will continue until all the bottles in the group have 1 sample placed in them (see NOTE on #2 above). The sampler will then wait for another event (contact closure or a time override elapse (see NOTE on #3 above)). When the event occurs the unit will place another sample in each bottle of the active group. This will continue, as events take place, until the specified number of Samples per Bottle is reached and all Bottle Groups have been utilized. See page 2-39 for a full explanation of how bottle groups are divided and what order the spout fills the bottles.

Display on LCD	Explanation
<p>SAMPLER READY 04/30 04:30:02</p>	This display indicates the sampler is ready to program and displays the current time. Press the * key to begin programming.
<p>ENTER * MODE — — 04:30:02</p>	The sampler is now prompting for a star mode to be input. Enter the numbers which represent the star mode of choice, in this example 12, and press <ENTER>.
<p>SAMPLES PER BOTTLE? — — 04:30:02</p>	Enter number of samples per bottle as a 2-digit number (1-99). Make sure the volume to be placed in the bottles is not greater than the actual volume of the bottles.

TIME OVERRIDE?
 ___ : ___ **04:30:02**

Enter in HH:MM format. Remember to allow enough time for the sampler to collect the required samples.

ENTER DELAY START
 ___ : ___ **04:30:02**

This display prompts the user to enter a delay start time (HH:MM format). This is the amount of time the sampler is to wait before starting.

ACTIVE PERIOD?
 ___ : ___ **04:30:02**

Enter a time (HH:MM format). This is the time window in which bottle groups are active. It applies to all bottle groups. Make sure it is long enough to allow the sampler to collect the number of samples required.

OF BOTTLE GROUPS?
 ___ **04:30:02**

Enter a 2-digit number (must be an integer). This is the number of bottle groups to be created from the number of bottles set in *99. The number of bottles will be divided by the number of bottle groups to determine how many bottles are in a group.

PUSH START/OPTIONS
 04:30:02

If no add-on options are desired, press <START> to begin the program.

DELAY START TIME
 ___ : ___ **04:30:02**

This display shows the time remaining on the Delay Start.

FLOW MODE (*12)
 ___ **04:30:02**

The sampler is now waiting to receive contact closures and is independently counting down the interval time.

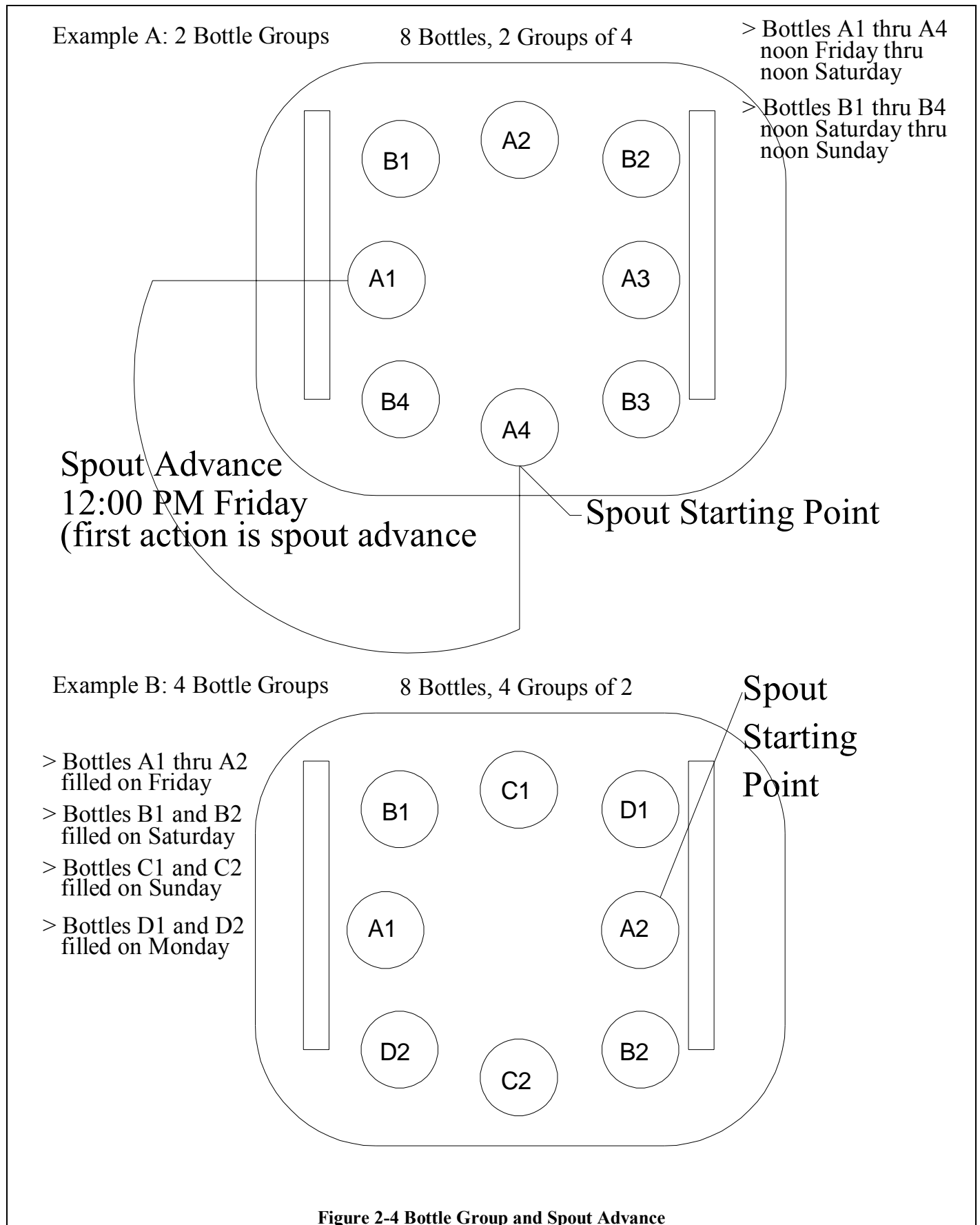

***13 Flow Mode - Totalizing Analog Multiple Bottle Composite with Bottle Groups**

The *13 mode functions in the same way as the *12 mode, except it integrates and totalizes an analog signal (4-20mA) from an external device that represents flow rate. Since the sampler does not ask for a definition of the volume unit of the flow rate, ANY can be used, i.e. cubic feet, liters or gallons. For more details on how the analog controller works, refer to the analog programming section on page 2-12. *13 is useful when it is not possible to collect samples on a regular basis, such as on a weekend or at a remote site. In this mode the user selects the number of bottle groups, how long each group is active (receives samples), the maximum number of samples a group will take, and a time override. NOTE: The number of bottle groups is entered, not the number of bottles in a group. After pushing <START>, the sampler immediately begins counting down the Delay Start. Once the Delay Start has finished counting down, the sampler will begin reading the analog signal and be ready to act on an event (totalized volume or time override). The finish of the Delay Start will also start the time override counting down. If the sampler receives an event, the unit will initiate the sampling sequence. There are several simultaneous actions:

- 1) The spout will advance to the first bottle in the active bottle group and begin the sampling process.
- 2) The active bottle group time will begin counting down. NOTE: Make sure the active time period allows enough time to collect all the samples required. If the active time period elapses before the Samples per Bottle has been satisfied, the unit will finish the sequence in progress and then move to the next bottle group without completing the current bottle group.
- 3) The time override will reset and begin counting down again. The override time causes the unit to take samples if the Flow Trigger fails to occur. The override time starts counting down immediately after pressing <START>. NOTE: The override time must be longer than the time it takes for the sampling sequence to complete. If it is not, the override time will elapse while the unit is in a sampling sequence causing another sequence to begin immediately after finishing the previous one.

The first bottle group will be active and receive all samples for its active time period, up to the maximum number of samples. If the maximum is reached, the sampler will still wait out the rest of the active time before switching to the next bottle group. After the initiation of a sampling sequence, the sampler will advance to the first bottle in the group. The unit will place 1 sample in this bottle, and then advance to the next bottle in the group and deposit a sample. This will continue until all the bottles in the group have 1 sample placed in them (see NOTE on #2 above). The sampler will then wait for another event (totalized volume or time override (see NOTE on #3 above)). When the event occurs the unit will place another sample in each bottle of the active group. This will continue, as events take place, until the specified number of Samples per Bottle is reached and all Bottle Groups have been utilized. See page 2-39 for a full explanation of how bottle groups are divided and what order the spout fills the bottles.

NOTE: In order for the sampler to correctly scale the analog signal being output from the external device, the parameters (in this case maximum and minimum flow) set in the sampler and the external device must be the same. This is to ensure that if the external device is reading 100,000 gallons and outputting a 4mA signal, the sampler will also know that 100,000 gallons is equal to 4mA. If the parameters do not correspond, there is a

risk that the sampler will potentially not scale the analog signal correctly and will subsequently not take samples at the anticipated or correct instances.

Display on LCD	Explanation
<p>SAMPLER READY 04/30 04:30:02</p>	<p>This display indicates the sampler is ready to program and displays the current time. Press the * key to begin programming.</p>
<p>ENTER * MODE — — 04:30:02</p>	<p>The sampler is now prompting for a star mode to be input. Enter the numbers which represent the star mode of choice, in this example 13, and press <ENTER>.</p>
<p>MAXIMUM FLOW RATE? — — — — 04:30:02</p>	<p>Input the 4 most significant digits of the Maximum anticipated flow rate. Since the unit of measurement is generic it can stand for any volume/unit of time. If the flow rate is 40, it could be entered as: 4000, 0400, or 0040. The decimal point is implied, in each case, so <u>be consistent with all entries.</u> Rate must be in units per minute.</p>
<p>MINIMUM FLOW RATE? — — — — 04:30:02</p>	<p>Enter the 4 most significant digits of the Minimum anticipated flow rate. The same criteria apply to this input as to Maximum Flow Rate.</p>
<p>FLOW MULTIPLIER? — — — — 04:30:02</p>	<p>The Flow Multiplier is used to scale the Maximum & Minimum Flow Rates. If the Max flow rate is 40,000, enter it as 4000 (first 4 significant digits). The user would then enter a Flow Multiplier of 10 (4000 x 10 = 40,000) to have the unit scale the flow rate as 40,000.</p>
<p>SAMPLE TRIGGER? — — — — 04:30:02</p>	<p>Enter the 4 most significant digits of totalized flow at which a sample should be taken. Remember the decimal point is implied and must be consistent with previous entries. If the user wanted to take a sample every 150,000 units, the entry would be 1500.</p>
<p>TRIGGER MULTIPLIER? — — — — 04:30:02</p>	<p>The Trigger Multiplier scales the Sample Trigger. Using the example above, if 150,000 units is the Trigger point, the Trigger Multiplier would be 100 (1500 x 100 = 150,000).</p>
<p>SAMPLES PER BOTTLE? — — — — 04:30:02</p>	<p>Enter the number of samples per bottle as a 2-digit number (1-99). Make sure the volume to be placed in the bottles is not greater than the actual volume of the bottles.</p>
<p>TIME OVERRIDE? — — : — — 04:30:02</p>	<p>Enter in HH:MM format. Remember to allow enough time for the sampler to collect the required samples.</p>
<p>ENTER DELAY START — — : — — 04:30:02</p>	<p>This display prompts the user to enter a delay start time (HH:MM format). This is the amount of time the sampler is to wait before starting.</p>

ACTIVE PERIOD?

— — : — — 04:30:02

Enter a time (HH:MM format). This is the time window in which bottle groups are active. It applies to all bottle groups. Make sure it is long enough to allow the sampler to collect the number of samples required.

OF BOTTLE GROUPS?

— — — — 04:30:02

Enter a 2-digit number (must be an integer). This is the number of bottle groups to be created from the number of bottles set in *99.

PUSH START/OPTIONS

04:30:02

If no add-on options are desired, press <START> to begin the program.

DELAY START TIME

— — : — — 04:30:02

This display shows the time remaining on the Delay Start.

FLOW MODE (*13)

— — — — 04:30:02

Once the Delay Start ends, the sampler will immediately begin reading the analog signal and begin counting down the Time Override.

Maintenance

Section Contents

Maintenance	Page C-1
Suggested Maintenance Schedule	Page C-1
Peristaltic Pump	Page C-2
Replacement of Pump Tubing	Page C-3
Cleaning the Control Panel and Electronics Enclosure	Page C-6
Cleaning the Wetted Parts	Page C-6
Intake Hose	Page C-7
Liquid Sensor	Page C-7
Bottle Full Sensor (Single Bottle Units Only)	Page C-8
Spout (Multiple Bottle Units Only)	Page C-8
Sample Containers	Page C-8
Refrigerator	Page C-8
Environmental Protection	Page C-10
Removing and Replacing the Controller	Page C-10
Troubleshooting	Page C-11
System Non-Responsive	Page C-11
Works Inconsistently	Page C-11
Weak Draw	Page C-11
Pump Operates but no Fluid	Page C-12
Pump Rotor Does Not Rotate	Page C-12
Purges Constantly	Page G-12
Low Sample Volume	Page C-12
Excessive Sample Volume	Page C-12
Controller Does not Respond to Command	Page C-12
Keypad Inoperative	Page C-12
*99 Self Test Indicates Error	Page C-12

Maintenance

Suggested Maintenance Schedule

The YB8 sampler requires only minimal maintenance to ensure proper and reliable operation. The following is a listed of suggested maintenance items and estimated times for accomplishing those tasks. Your actual times and needs may differ.

Plan	Item	Frequency	Time	Description of Maintenance
Maintenance	Lubrication	Only as needed	10 min	The peristaltic pump requires no regular lubrication.
Inspection Maintenance	Pump Tubing	Every Week	1 min	See Below.
Inspection Maintenance	Pump Case	Every Month	3 min	Manning recommends occasional cleaning to remove particulates that if caught between the wall and the tube, can cause increased wear of the pump tubing. Do not apply any oil or other lubricating substances to the pump body as this will inhibit the ability of the pump to operate correctly and will significantly impact the life of the pump tubing.
Inspection Maintenance	Pump Rollers	Every Month	2 min	Manning recommends occasional cleaning to ensure smooth rolling and less wear of pump tubing.
Inspection Maintenance	Clear Pump Lid	Every Month	3 min	Check to ensure that the clear lid is clean of residual materials and contaminants so that the operation of the pump can be clearly seen.
Inspection Maintenance	Strainer	Every Week	10min	Ensure that the strainer is not collecting materials that would inhibit fluid from reaching the pump. If material is collecting, clean the strainer and reposition at the appropriate spot in the flow stream.
Inspection Maintenance	Intake tubing connectors	Every Week	4 min	Ensure that the connectors are fitting tightly together. This ensures the sampler is not experiencing vacuum leaks which can degrade the samplers performance.
Inspection Maintenance	Liquid Sensor	Every Week	2 min	Inspect the liquid sensor. Continuity Type - Make sure that good connection is being made on the continuity sensor. Check to make sure that no foreign matter is making a connection between the leads. Cleaning of the inside of the sensor is recommended to ensure good continuity is maintained for the detection of liquid. Ultrasonic - Make sure that good contact is being made between the tubing and the ultrasonic sensors. The tubing should be seated firmly in the sensor block with the tubing in solid contact with the walls of the sensor.
Inspection Maintenance	Intake tubing	Every Month	10 min	Check the intake tubing to ensure that it is clean. Cleaning can be accomplished by running a cleaning solution through the tubing by using the test cycle feature of the unit.

Inspection Maintenance	Discharge Tubing	Every Month	3 min	Examine the discharge tubing for build up of organic and particulate matter. If there is build up, follow the same procedure for cleaning the intake tubing. Replace as necessary.
Inspection Maintenance	Electronics Enclosure	Every Month	2 min	Clean as needed with warm water and very mild soap
Inspection Maintenance	Keypad	Every Month	2 min	Clean as needed with warm water and very mild soap. Harsh abrasive cleaning products can damage the keypad and scratch the clear window to the display
Inspection Maintenance	Sealing Gasket	Every Year	5 min	Unscrew the electronics enclosure from the refrigeration system and ensure that the gasket is free from debris and is maintaining its shape and consistency. If the gasket is exhibiting signs of wear, contact the Manning service department for information on replacement. Under normal operating conditions, the gasket should provide many years of life
Inspection Maintenance	Sample Bottles	As often as needed	15 min	The sample bottles should be checked frequently to ensure that they are clean. EPA cleaning protocol should be used in the cleaning of the bottles.
Maintenance	Z-Rust Capsule	Every Year	8 min	Once a year, the Z-rust capsule which is used to absorb moisture (in the form of humidity) should be replaced
Maintenance	Lithium Battery	Every 3-5 years	12 min	The sampler contains an internal lithium battery which should be replaced every 3 to 5 years

Peristaltic Pump

The peristaltic pump used in the Manning Environmental Inc. YB8 is designed for long life and trouble free service. The following is a list of routine maintenance items:

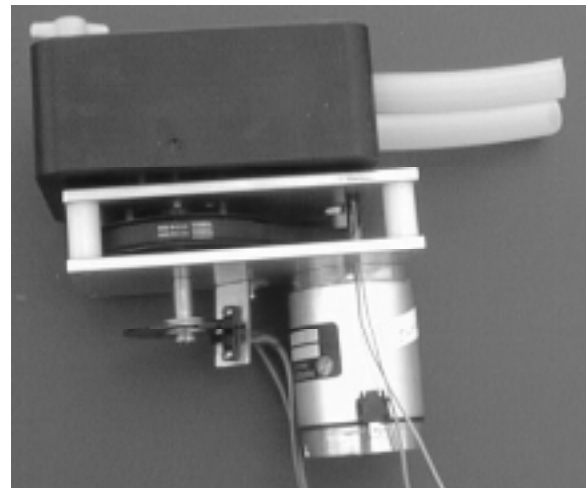
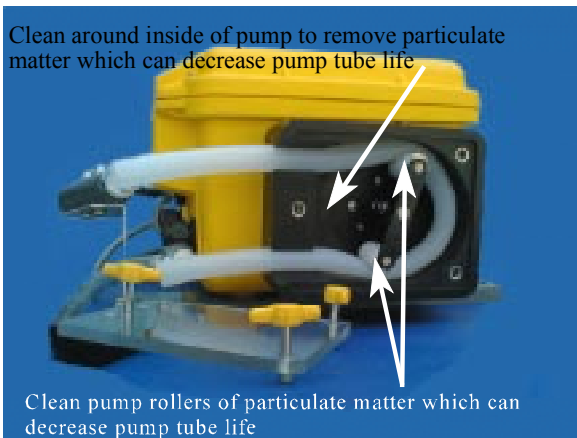

Lubrication	The peristaltic pump requires no regular lubrication. If chattering starts to occur in the pump rollers, a very small amount of very lightweight oil may be applied. If the chattering does not stop, replacement may be necessary.
Pump Tubing	See Below.
Pump Case	Manning recommends occasional cleaning to remove particulates that if caught between the wall and the tube, can cause increased wear of the pump tubing.
Pump Rollers	Manning recommends occasional cleaning to ensure smooth rolling and less wear of pump tubing.

Replacement of Pump Tubing

WARNING: Always disconnect the power to the sampler before opening the pump to replace the tubing. Failure to do so may lead to serious injury.

The peristaltic pump used on the Manning Environmental Inc. Model YB8 has been designed to facilitate the changing of pump tubing. The unit is mounted in a vertical position. The unit also employs a clear plastic face plate to allow the user not only to see how the tubing should lie within the pump but also to aid in tubing alignment and to allow the user to visually verify that the pump is operating correctly. Perform the following steps to change the pump tubing:

WARNING: The orientation of the intake and discharge hoses must not change when replacing the tubing. If the orientation changes, the unit will operate in reverse of its proper operating procedure. This means it will try to draw a sample out of the sample container instead of out of the source liquid.

- 1) Verify there is no power being applied to the unit. The unit has an integral safety kill switch which is intended to prevent powered rotation to the pump should the clear plastic face plate be removed. However, power should always be turned off to the unit as an added measure of safety.
- 2) Remove the 3 thumb screws which hold down the clear plastic face plate. Lift off the plate.
- 3) Remove the tubing from the liquid connectors which are attached to the liquid sensor (continuity type). For ultrasonic type liquid sensors, disconnect the tubing from the liquid connectors and then slide the hinged lid of the top of the liquid sensor and then pull the tubing out of the liquid sensor. Then remove the tubing from around the rollers. There are no designated ends on the tubing so the

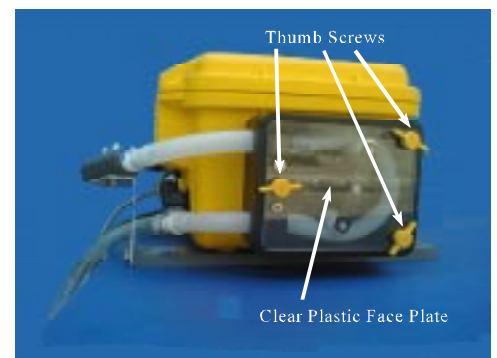

orientation (which end is placed on the inlet side and which end is placed on the outlet side) does not matter.

4) Place the new tube in the pump making sure it is seated flush against the inside wall of the pump. Pushing on the tube to get it flush against the back wall of the pump will help. It should follow the curve of the cavity with no gaps between the tubing and the wall and have equal amounts of tubing extending out past the pump housing.

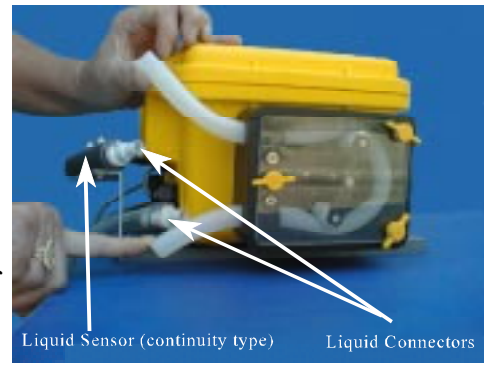

5) Once the tube is back in place, reconnect the tube to the liquid connectors or in the case of the ultrasonic sensor, replace the tube in the sensor, making sure that it is seated in the bottom of the sensor and that good contact is made with both walls of the sensor. Close the hinged lid and secure. Re-install the clear plastic face plate and tighten it securely with the 3 thumb screws removed earlier. Do not overtighten the screws. The face plate is made from clear material to aid in confirming that the pump tubing is correctly installed. Now that the cover is back on, look through it and make sure the tubing still follows the curve of the pump cavity with no gaps. Also verify that equal lengths of the tube extend out both the inlet and outlet sides of the pump. Insert the connectors back into the ends of the pump tubing making sure to maintain the orientation of the intake and discharge lines. Run a test cycle and check to see that when the pump is turning that the tubing is staying in place within the pump and that it is not “riding” up or down. If the tubing is “riding up or down, you can affect this by twisting the tubing at the inlet to the pump either clockwise or counterclockwise as the pump is turning. You should see the tubing either go up or down when twisted. Twist it till the tubing is centered between the rollers and stays there when the pump is going forward or backward.

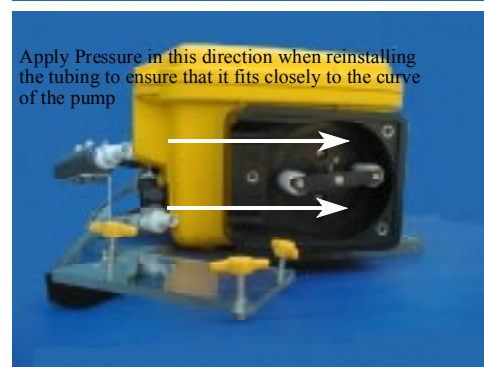

6) Reset the tube life pump count in *19. A peristaltic units ability to operate and perform to specifications, such as transport velocity and lift height is, to a certain extent, determined by the medical grade silicone rubber pump tubing used in the system. The characteristics of the tubing change as it wears. It becomes less resilient, less able to maintain its shape, develops pinch points on the outside edge of the tube, and as such is not capable of the performance it had when it was new. To maintain optimum performance, it is necessary to monitor the wear on the tube. *19 does this by enabling the operator to set a maximum number of pump revolutions, the tube currently in use, will be allowed to withstand. This, in effect, determines the tube's useful life. Manning recommends not exceeding 1,000,000 pump revolutions for a singular tube as, by this time, there is risk that the tubing could fail causing a variety of problems. *19 should be used every time the pump tubing is changed. The user will be alerted to change the tubing, when the tubing reaches the number of counts set. The warning will appear, every time the user executes a

Program Mode, by pressing <START>. Since all programs are initiated by pressing <START> the warning will always appear, if appropriate, before the program is initiated. This allows the user the opportunity to exit the program and change the tubing. Once the tubing is changed, the user can re-enter the program and begin sampling.

When the pump tubing is to be changed, the user will enter into *19 Mode, just like entering any of the other * Modes. The sampler will prompt the operator to clear the current pump count by pressing 1, or to maintain the current count by pressing 0. It is advisable to reset the pump counts when changing the tubing so an accurate accounting of the number of revolutions, the tube in the pump has experienced, can be obtained. At this juncture the user will be asked to enter a number for the tube life warning which represents the number of revolutions the current tube will be allowed to accumulate before a warning is issued. Once entered, the system will return to the sampler ready prompt and the system will be ready to program.

Display on LCD	Explanation
<p>SAMPLER READY 04/30 04:30:02</p>	<p>This display shows the sampler is ready to program. It displays the current time. From here the user can enter any TIME, FLOW, or * Mode. Press the * key to access the * Mode.</p>
<p>ENTER * MODE? _ _ 04:30:02</p>	<p>Prompts the user to enter either a program or a * Mode. Press 19 and <ENTER> to proceed.</p>
<p>0=MAINTAIN 1=CLEAR _ 04:30:02</p>	<p>This prompt is asking the user to determine how the system will handle the current accumulation of revolutions:</p> <ul style="list-style-type: none"> 0 - This maintains the current revolution count. This is useful if the operator wishes to increase the number of revolutions the current tubing can accumulate before a tube life warning is issued. For example, assume the current tubing has 200,000 revolutions. The operator really wants the warning to come on at 400,000. The 0 key would be pressed instead of 1 to maintain the history the tubing has already generated. The user would then enter 0400 (for 400,000) at the TUBE LIFE WARNING prompt (see below). 1 - This resets the current revolution count. This is necessary if the user is going to be placing brand new tubing into the system. With the counter reset the user knows exactly how many counts it will take for the sampler to issue a warning to change the tubing.

TUBE LIFE WARNING?

04:30:02

Enter the maximum number of revolutions the tubing will accept before the sampler issues a pump tube warning. The number entered is in terms of thousands (in other words it adds 3 0's to the end of the number entered) so if 0500 is entered, the sampler would see it as 500,000. Entering 4000 equals 4,000,000 and 0060 would be 60,000, etc. When the number of revolutions meet or exceed the pump counts set by the user, a pump life warning will be issued. The default is 1,000,000.

Cleaning the Control Panel and Electronics Enclosure

Use a mild cleaning solution and wipe with a soft, lint-free cloth. The clear window on the membrane keypad is easily scratched, so be very careful when cleaning. The exterior of the electronics enclosure is constructed of thick walled injection molded structural resin and is designed to withstand a wide variety of conditions. The unit conforms to NEMA 4X,6 criteria, when the unit is latched shut. Please be sure to close and latch the unit when not programming. This will ensure that the keypad is not exposed to the elements and will increase its useful life.

CAUTION: Do not use harsh cleaners (detergents, solvents, etc.) which can damage the panel surface. Do not use abrasives which can scratch the panel and fog the window above the LCD display.

Cleaning the Wetted Parts

Note: Solvents and solvent contaminated fluids must be disposed of according to approved procedures.

Manning Environmental Inc. recommends instituting a cleaning regime for the sampling equipment. The following are a few of the many reasons why a cleaning regime is important:

1. It validates that the samples taken will be as free as possible from constituents that are not contained within the sample itself.
2. It contributes to ensuring that the statistical validity of the samples being examined will be maximized by reducing systematic error, if the regime is followed very closely.
3. It contributes to the longevity of the sampling equipment.
4. It provides documentation for challenged results.

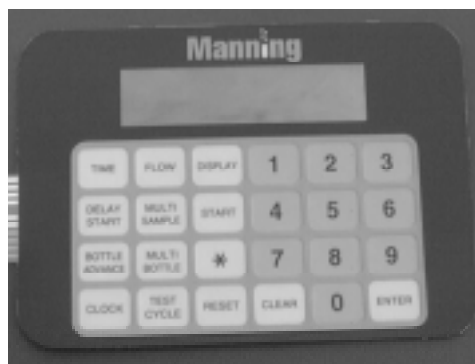

For a detailed description of a cleaning protocol refer to U.S. Environmental Protection Agency Publications

EPA-600/4-77-039 ("Sampling of Water and Wastewater" by Dr. Phillip E. Shelley), or consult with the facility that will do the actual testing of the samples. They could probably assist in setting a cleaning regime that will help produce the most accurate results possible.

The following procedures are very general outlines of procedures for cleaning certain parts of the sampler:

Intake Hose

There are two types of intake hose used with the sampler - PVC and Teflon[®]. PVC intake hose is used for general purpose sampling (Non-Toxic) applications. Teflon[®] hose is used for priority pollutant sampling (Toxic) applications.



1. Remove the intake hose. Remove the strainer if necessary.
2. Wash the intake hose and strainer using a cleaning solution appropriate for the application. The use of methylene chloride or other solvents may leave a residue that could contaminate the sample. Use a test tube brush to scrub the internal surfaces of the strainer. Pull the brush through the hose with a wire to clean the internal surfaces of the hose.
3. Rinse the hose and strainer thoroughly in clean water (warm water is best) and reassemble.

It may be easier and more convenient to simply use a new hose for each sample configuration. This eliminates cleaning and disposal of potentially hazardous regulated chemicals.

Liquid Sensor

The continuity type liquid sensor will need to be cleaned occasionally. Like any piece of the sample tract, it has the ability to collect particulate matter, which needs to be removed. By removing this particulate matter, it ensures that you will receive optimum performance from the unit.

The ultrasonic liquid sensor will not need to be cleaned. By changing the pump tubing you in effect, clean, the ultrasonic sensor.

1. Remove the pump tubing from the liquid connectors.
2. Insert a bottle brush or other scrubbing type device and vigorously insert the scrubber in and out of the sensor.
3. Reconnect the pump tubing to the liquid connectors and run a manual cycle with clean

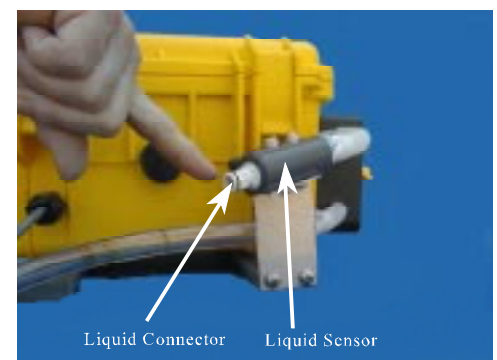

water to flush any material that was removed from the liquid sensor out of the sample tract.

Bottle Full Sensor (Single Bottle Units Only)

1. Locate the bottle full sensor in the neck of the bottle. Either remove the leads from the ends of the bottle full sensor probes or disconnect the black rubber mating connector. Remove the bottle full sensor from the discharge line by sliding it off.
2. The unit is made of high grade stainless steel which is approved by the EPA for toxic or non-toxic applications. Clean the probes, ensuring that there is no buildup on the stainless steel probes.
3. Reconnect the unit, reversing the procedure used to remove it. If you disconnected the leads from the stainless steel probes, make sure they are firmly attached.

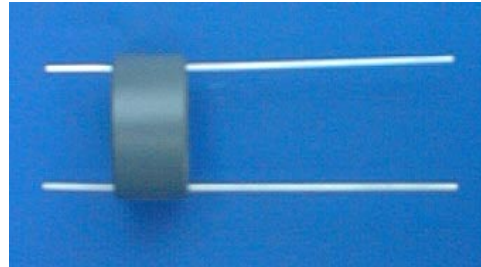

Spout (Multiple Bottle Units Only)

1. Remove the spout from the upper union by gently pulling the spout gear from below. (Rotating back and forth may help).
2. Wash the spout with the appropriate cleaning solution. Use a test tube brush to clean the internal surfaces of the spout and upper union.
3. Rinse thoroughly with clean water (warm water is best) and re-assemble. When replacing the spout, the timing mark on the stepper motor gear must align with the timing mark on the spout gear.

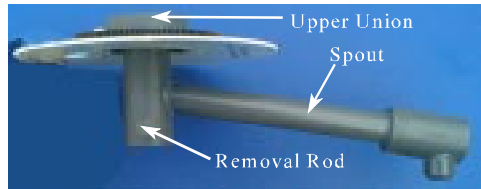

Sample Containers

1. Wash with the appropriate cleaning solution. Use a test tube brush to clean the internal surfaces.
2. Rinse thoroughly in clean water (warm water is best).
3. Autoclave glass bottles, if desired. Do not autoclave plastic bottles or caps since they are constructed of polyethylene.

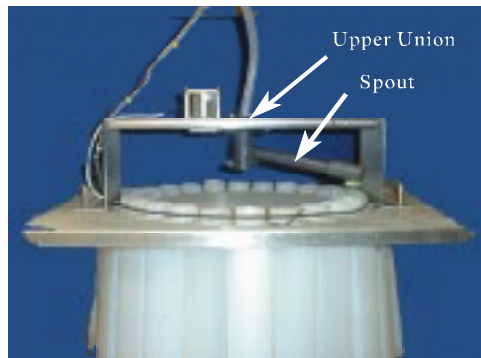

Refrigerator

The refrigerator that comes with the YB8 is an industrial grade unit. It has many features and options that are not found on consumer models. These features make it more resistant to weather, allow it to maintain EPA recommended temperatures, and ensure long life in the harshest environments. As durable as the refrigerator is there are things that can be done to promote longer life. These items are covered here, but are also covered in the manual that comes with the refrigerator. If you should encounter problems that cannot be addressed with this manual or the manual included with the refrigerator, please contact Manning for assistance.

Condenser

The condenser tubing under the cabinet for forced air units does not require frequent cleaning; however, satisfactory cooling depends on adequate ventilation over the condenser. Be sure that nothing obstructs the air flow openings in the lower front of the cabinet. At least once or twice a year brush or vacuum lint and dirt from the condenser for efficient performance by unscrewing the grill on the bottom front of the cabinet

Cabinet

The stainless steel or painted cabinet can be washed with mild soap and water and thoroughly rinsed with clear water. Never use abrasive scouring powders.

Interior and Door Gasket

Wash interior compartment with mild soap and water. Mix 2 tablespoons of baking soda with one quart of warm water. Do not use abrasive powders, solvent, polish cleaner or undiluted detergent.

Energy Saving Tips

- A. Reduce door openings as much as possible
- B. Close the door as soon as possible after opening
- C. Keep the coils on the bottom of the refrigerator clean
- D. Adjust the temperature control to a warmer temperature when maintaining 4⁰C is not necessary
- E. Don't put hot material into the refrigerator
- F. Keep the refrigerator away from heat generating equipment

Troubleshooting

Problem	Possible Cause/Solution
Odor in Cabinet	Interior needs cleaning
Noisy Operation	Cabinet not level
Cabinet Vibrates	Cabinet not level
Appliance will not run	Temperature control turned to OFF Line cord not plugged in No power at electrical outlet Blown fuse

Appliance runs to long

Prolonged door openings
Control set to cold
Condenser needs cleaning

Moisture collects inside

To many door openings
Prolonged door openings
Hot humid weather increases condensation

Moisture collects on outside surface

Hot humid weather increases condensation, as
humidity decreases, moisture will disappear
Control set improperly

Interior too hot/too cold

Control set improperly
Faulty thermostat

Temperature Control

Initially set the cold control knob midway between the numbers. The dial setting is established at the top of the knob. After at least 2 hours, adjust to the temperature that suits you. The higher the number you select the cooler the temperature. The temperature control knob is located at the bottom front of the cabinet, just behind the square opening near the middle of the grill.

Environmental Protection

Once a year (or as necessary) replace the Zerust sponge inside the enclosure. If the sampler is in an area of high humidity, additional desiccant may be necessary.

Removing and Replacing the Controller

To remove the controller, remove the hold down screws, disconnect the cables, hose, and tubes.

To replace the controller, reinstall the hold down screws and reconnect the cables, hose and tubes.

Troubleshooting

Troubleshooting instructions are based on a logical sequence of events leading to a malfunction. If trouble occurs, look for the simplest solution first such as whether the power supply is connected. Are any connections loose or wires broken? Review the problem, normal operating procedures, and then check one possibility at a time starting with the easiest to verify. If the malfunction continues, call the Manning Environmental, Inc. Service Department at 1-800-863-9337. We can often assist over the phone. We can also advise on whether or not certain repairs are best done in the field or in our factory.

Note: Follow instructions in the Maintenance section when removing the controller (see page 3-4)

Problem	Possible Cause	Remedy
System Non-Responsive	Circuit Breaker Tripped	Turn on/off switch back to on.
	Loose Connection	Check connectors on circuit board. Tighten if necessary.
	Controller Lock-Up	Push the hard RESET button located on the lower left side of the processor board. Note: Re-enter configuration data (*99) and stepper motor data (*90).
	Controller Failure	Remove and replace controller.
Works Inconsistently	Faulty Wiring	Check wiring, starting with power connections.
	Controller Failing	Remove and replace controller or failed board.
Weak Draw	Intake Hose Pinched	Check hose for pinch or damage. Replace if damaged.
	Hose or Line Clogged	Flush with water to clear clog.
	Air Leak	Check pump tubing for damage.
	Peristaltic Pump Failing	Check pump for proper operation including: Drive belt is intact, Drive pulleys are rotating, Rollers are rotating freely, Impediment in pump tubing, Motor not humming.

Pump Operates but No Fluid	Hose or Line Clogged Peristaltic Pump Failing	Flush with water to clear clog. Check pump for proper operation including: Drive belt is intact, Drive pulleys are rotating, Rollers are rotating freely, Impediment in pump tubing, Motor not humming.
Pump Rotor Does Not Rotate	Peristaltic Pump Failing	Check pump for proper operation including: Drive belt is intact, Drive pulleys are rotating, Rollers are rotating freely, Impediment in pump tubing, Motor not humming.
Sample Does Not Enter Container	Deposit Line Blocked	Clear the line.
Purges Constantly	Controller Failure Motor Relay Failure	Remove and replace controller or failed board. Check to see that relay changes from purge to draw mode.
Low Sample Volume	Fluid Detector Malfunctioning Excessive Tube Wear RPM Counter Malfunctioning	Check calibration of Fluid Sensor or replace the Fluid Sensor. Replace pump tubing. Replace the RPM counter.
Excessive Sample Volume	Fluid Detector Malfunctioning RPM Counter Malfunctioning	Check calibration of Fluid Sensor or replace the Fluid Sensor. Replace the RPM counter.
Controller Does not Respond to Command	Password Active	Enter the password at prompt.
Blank Display	No Power Display Failure	Check to make sure sampler has power. Check connections and possibly replace display.
Keypad Inoperative	Membrane Switch Failure	Remove and replace membrane switch.
*99 Self Test Indicates Error	Controller Failure	Remove and replace controller.

Glossary

Alarm Option	Factory installed option which can be connected to a remote site, and which provides flashing lights and/or an audible alarm to alert the user of missed samples, cycle in progress, or completion of the sampling sequence.
Analog Option	Allows the sampler to accept external flow rate signals.
Bottle Advance	Action of spout as it moves from one bottle to the next bottle in a sampling sequence.
Bottle Groups	In bottle group sampling modes (*12 and *13) bottles are grouped by time period. For example, bottle group A might be filled on Saturday, and bottle group B might be filled on Sunday.
Composite Sampling	Same as single bottle sampling. Samples are placed in one bottle.
Configuration Function	Initial program which must be entered to use the sampler. Defines the type of sampler, password, number of bottles, and other information essential for the proper operation of the sampler. Accessed with the *99 command.
Contaminants	Biological, chemical, or other types of foreign materials.
Contact Closure	When a flow or level instrument records a pre-set change in level, an electrical impulse is generated (or energized) causing a contact to close. If the flow meter is attached to a sampler programmed to accept contact closures, this causes a sample to be taken.
Control Panel	Same as the controller. Keypad and system electronics on the electronics enclosure. Used to enter programming instructions.
Default Value	Values which are used by the controller unless you change them.
Discrete Sampling	Same as multi-bottle sampling. Samples are placed in multiple bottles.
Distribution Assembly	Spout, stepper motor and spout gear.
Electronics Enclosure	Unit which sits on top of the refrigerator and contains the controller, and the peristaltic pump.
Flow Option	Allows the sampler to be connected to a flow meter.
General Purpose Sampling	Also referred to as non-toxic sampling.

Glossary

CONTINUED...

Hydrologic Event	An event which effects flow, volume, or flow rate of water. For example, a flood is a hydrologic event.
LCD	Liquid crystal display screen.
Methylene Chloride	A cleaning solvent. Must be disposed of according to locally approved procedures.
Negative Differential Stage	Falling change in water level during a hydrologic event.
Positive Differential Stage	Rising change in water level during a hydrologic event.
Priority Pollutant Sampling	Same as toxic sampling. Sampling of chlorine based compounds, hydrocarbons, and other similar pollutants.
RESET	A key on the keypad. Used to clear and reset the controller, cancel current programmed mode, and turn of an audible alarm, if installed.
Resolution	Input span accuracy (significant in the *06 and *09 modes).
Span	(Used with the *06 and *09 modes) Difference between maximum and minimum analog levels or flow rates.
Suspension Plate	Rectangular stainless steel plate which holds the sample bottles in place.
Sub-assemblies	A group of different parts which can be installed into a sampler as a unit. Often performs a specific function independently.
Timing Marks	Black marks on spout motor gear and stepper motor gear. Used to synchronize the gears.
Weighted Strainer	Attached to the intake hose. Prevents large particles from entering the intake line. Also keeps the hose inlet at the desired level between samples.

Appendices

Section Contents

Appendix A.....	Page D-1
How to Return Equipment	Page D-1
Address for Repairs.....	Page D-1
Parts List	
Errata	

Appendix A

How to Return Equipment

Call or write the Manning Environmental Service Department before returning any equipment for repair. Many problems can be diagnosed and resolved over the telephone. Manning will issue a Return Material Authorization (RMA) number if it is deemed necessary that the equipment be returned for repair.

If you do need to return equipment, follow these guidelines:

- Pack equipment carefully, preferably in the original carton.
- Enclose specific information about the problem.
- Enclose a contact name and phone number in case our Factory Service Department needs additional information.
- Enclose a purchase order authorizing repairs.
- Ship the equipment to the address below. Our Receiving Department will not accept collect shipments.

The Service Department phone number is (800) 863-9337. The Service Department will notify you of the type of repair needed and an estimate of how much the repair will be. Manning will ask for authorization before proceeding.

Address for Repairs:

Manning Environmental, Inc.
RMA _____
101 Bar T Drive
Florence, Texas 76527-4445

YB8 Parts List 04/24/12

Pump Tubing, Intake Hoses, Strainers, and Fittings

Part Number	Description	U/I	Qty
MS889923	Pump tubing, 22" length (for samplers with ultrasonic fluid sensor)	Ea	A/R
MS889925	Pump tubing, 18" length (for samplers with continuity fluid sensor)	Ea	A/R
MS566925B	Pump tubing, bulk	Ft	A/R
MS552104	Female quick-disconnect hose fitting (April 2012 and earlier)	Ea	A/R
MS552105	Male quick-disconnect hose fitting (April 2012 and earlier)	Ea	A/R
MS552110	3/8" Male hose coupling (May 2012 and later)	Ea	A/R
MS552111	3/8" Female hose coupling (May 2012 and later)	Ea	A/R
MS552062	3/8" Barb to barb fitting (May 2012 and later)	Ea	1
MS566917	Bulk clear PVC hose, 3/8" ID	Ft	A/R
MS566931	Bulk PTFE hose, 3/8" ID	Ft	A/R
MS889147	Strainer, PVC, 3/8" intake	Ea	A/R
MS579591	Strainer, stainless steel, 3/8" intake	Ea	A/R
MS552171	Fitting, compression, modified for use with PTFE hose	Ea	A/R

Multi-Bottle Distribution Assembly and Parts

Part Number	Description	U/I	Qty
MS889702	Distribution assembly, stationary sampler, 3/8" intake with PVC spout	Ea	1
.MS889081	Spout assembly, PVC, 3/8" intake	Ea	1
.MS889707	Stepper motor assembly w/rubber connector	Ea	1
.MS889729	Stepper motor assembly w/plastic connector	Ea	1
.MS552096	Upper union, 3/8"	Ea	1
.MS542186	O-Ring, upper union	Ea	1
.MS542202	O-Ring, upper union	Ea	1
MS889689	Suspension plate, 24 bottle	Ea	1
.MS542224	O-ring, bottle retaining	Ea	1
.MS612991	Cable tie, pushbutton	Ea	1

Bottles

Part Number	Description	U/I	Qty
MS687547	2.5 Gallon polyethylene bottle with cap	Ea	A/R
MS687551	4 Gallon polyethylene bottle with cap	Ea	A/R
MS889715	2.5 Gallon glass bottle with cap with Teflon-lined lid	Ea	A/R
MS685535	5 Gallon polyethylene bottle with cap	Ea	A/R
MS889117	Bottle Set, 24 1000mL polyethylene bottles with caps	Ea	1
.MS687533	1000mL polyethylene bottle (no cap)	Ea	A/R
.MS564241	Bottle cap for 1000mL and 500mL polyethylene bottles	Ea	A/R
MS889041	Bottle set, 24 500mL polyethylene bottles with caps	Ea	1
.MS687534	500mL polyethylene bottle (no cap)	Ea	A/R

Mechanical Parts and Miscellaneous Accessories

Part Number	Description	U/I	Qty
MS542232	Seal, V-ring	Ea	1
MS783027	Zerust vapor capsule	Ea	1
MS545059	Grommet, enclosure, stepped	Ea	1
MAN-YB	Manual, YB8 sampler	Ea	A/R
MS818016	Contact/pulse/analog input cable, 3' long	Ea	A/R
MS818018	Contact/pulse/analog input cable, 10' long	Ea	A/R
MS810059	Serial out patch cable, 6' long	Ea	A/R
MS818013	Cable, assembly, alarm, 3'	Ea	A/R
MS885503	Fluid sensor, continuity, field replacement with quick-disconnect fittings	Ea	1
MS885034	Fluid sensor, continuity, field replacement with barbed fittings	Ea	1
MS885014	Conversion kit, YB8 multi-bottle to single bottle	Ea	A/R
MS889831	Bottle full sensor, 3/8"	Ea	1
MS818029	Cable, bottle full sensor w/rubber connector	Ea	1
MS818031	Cable, bottle full sensor w/plastic connector	Ea	1
MS889404	Refrigerator, YB8, 6.1CF white, 110VAC 60Hz	Ea	1
MS889892	Refrigerator, YB8, 6.1CF stainless steel 110VAC 60Hz	Ea	1
MS889893	Refrigerator, YB8, 6.1CF white, 220VAC 50Hz	Ea	1
MS889026	Refrigerator, YB8, 6.1CF white, 110VAC 60hz w/digital temperature control.	Ea	1
MS889030	Refrigerator, YB8, 6.1CF stainless steel, 110VAC 60hz w/digital temperature control.	Ea	1
MS889036	Refrigerator, YB8, 4.1CF, 110VAC 60Hz (<i>for single bottle samplers only</i>)	Ea	1



101 ♦ BART ♦ DRIVE
FLORENCE ♦ TEXAS ♦ 76527-4449
Phone 254-793-9955 FAX 254-793-9965
www.manningenviromenal.com

12 March 2014

Errata for the YB8 Sampler Manual.

This document contains changes and corrections to the Operating and Instruction Manual for the Model YB8 Manning Stationary Peristaltic Sampler, Revision 0-600. .

Contents.

1. Revision 3 Ultrasonic Fluid Sensor.
2. Fluid Sensor Types.
3. Connecting the Sampler to an External Device.
4. Serial Out Option.
5. Alarm Option.
6. Battery Backup Option.
7. New Hose Couplings for YB8.
8. YB8 Theory of Operation.

Revision 3 Ultrasonic Fluid Sensor.

The Revision 3 of the ultrasonic fluid sensor uses updated electronics to improve reliability of the sensor. Unlike the earlier versions, it is not necessary to apply grease to the sensor body.

The fluid sensor is located on the inlet side of the peristaltic pump, mounted to the right front side of the sampler electronics enclosure. The pump tubing passes through the fluid sensor body. See Figure 1.

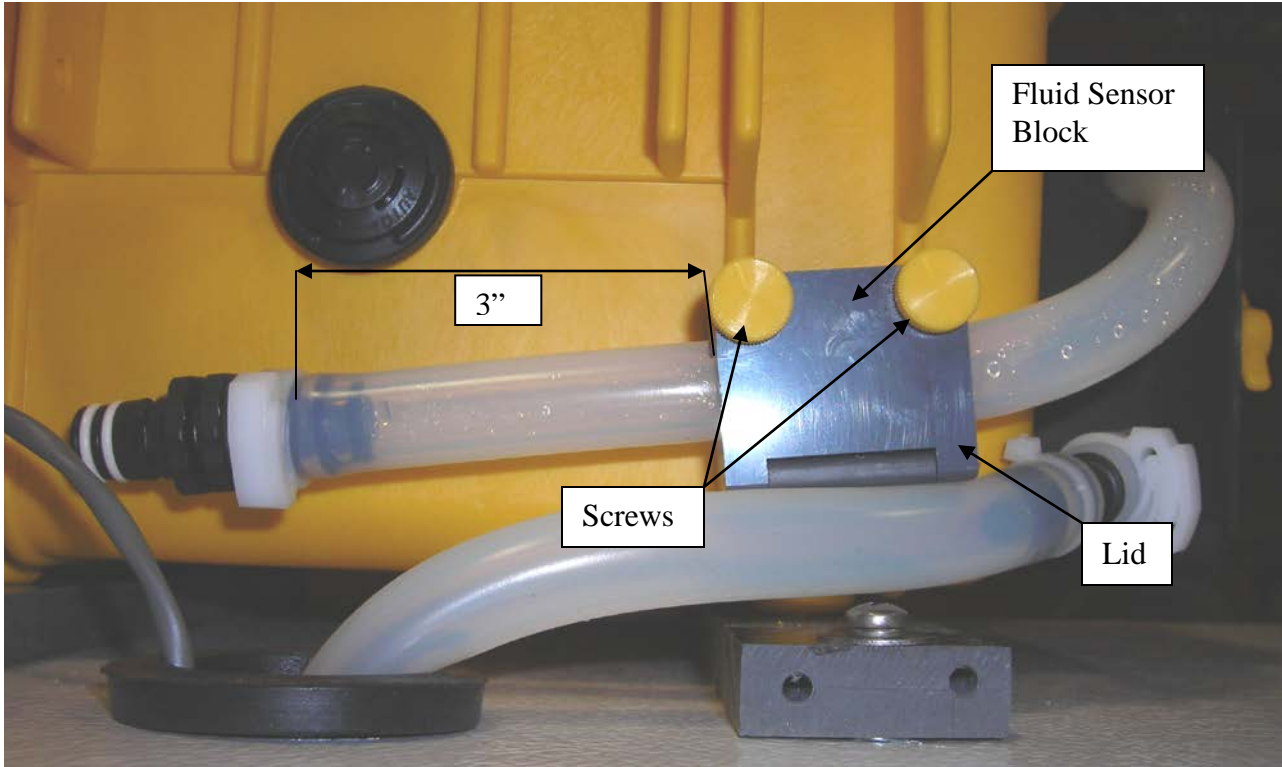

Figure 1.

The pump tubing is held in place in the sensor block by a hinged cover and two screws. To remove the pump tubing from the sensor, first remove the two screws from the cover and then open the cover up.

To install the pump tubing in the fluid sensor, first route the pump tubing through the fluid sensor and then the pump body, so that 3" of tubing extends from the inlet (left) side of the fluid sensor. (Note: Order part number MS889923 for a 22" piece of pump tubing, or MS566925B for bulk tubing if replacing the pump tubing). Do not stretch tubing in fluid sensor. Then, run a test cycle with the intake hose disconnected to make sure the pump tubing is properly seated in the pump body. Rotate the pump tubing as required to seat it. (Note: the pump lid must be on in order for the pump to run) With the pump tubing properly seated, close the hinged cover on the fluid sensor and secure it with the two screws. Remove the quick disconnect fittings from the old pump tubing and inset them into the ends of the newly installed tubing. Connect the discharge hose to the pump tubing.

Fluid Sensor Types.

Manning offers two different types of fluid sensors on its peristaltic samplers. The continuity fluid sensor detects the presence of fluid by passing an electric signal between two probes in the sensor, using the fluid as a conductive medium. The continuity fluid sensor works in a wide range of applications, as

long as the fluid being sampled is sufficiently conductive enough. Also, if the fluid causes the inside of the sensor body to be coated, the sensor may not properly detect the presence fluid.

The ultrasonic fluid sensor detects the presence of fluid by transmitting sound waves through the fluid. Because sound travels better through a fluid than through air, the sensor can detect if fluid is present or not. The ultrasonic fluid sensor works in most applications. It does not make physical contact with the fluid, and is not affected by the fluid's conductivity or temperature. Air bubbles in the fluid can cause the sensor to not detect fluid reliably, as they reduce how well sound travels through the fluid.

Connecting the Sampler to an External Device.

Manning samplers can be operated using inputs from external devices such as flow meters and Programmable Logic Controllers (PLC's) to trigger samples. A 4-pin female panel connector is located on the sampler chassis and is used in conjunction with a cable to make the connections.

Samplers come standard with a 3-foot cable. A 10-foot cable is available as an option.

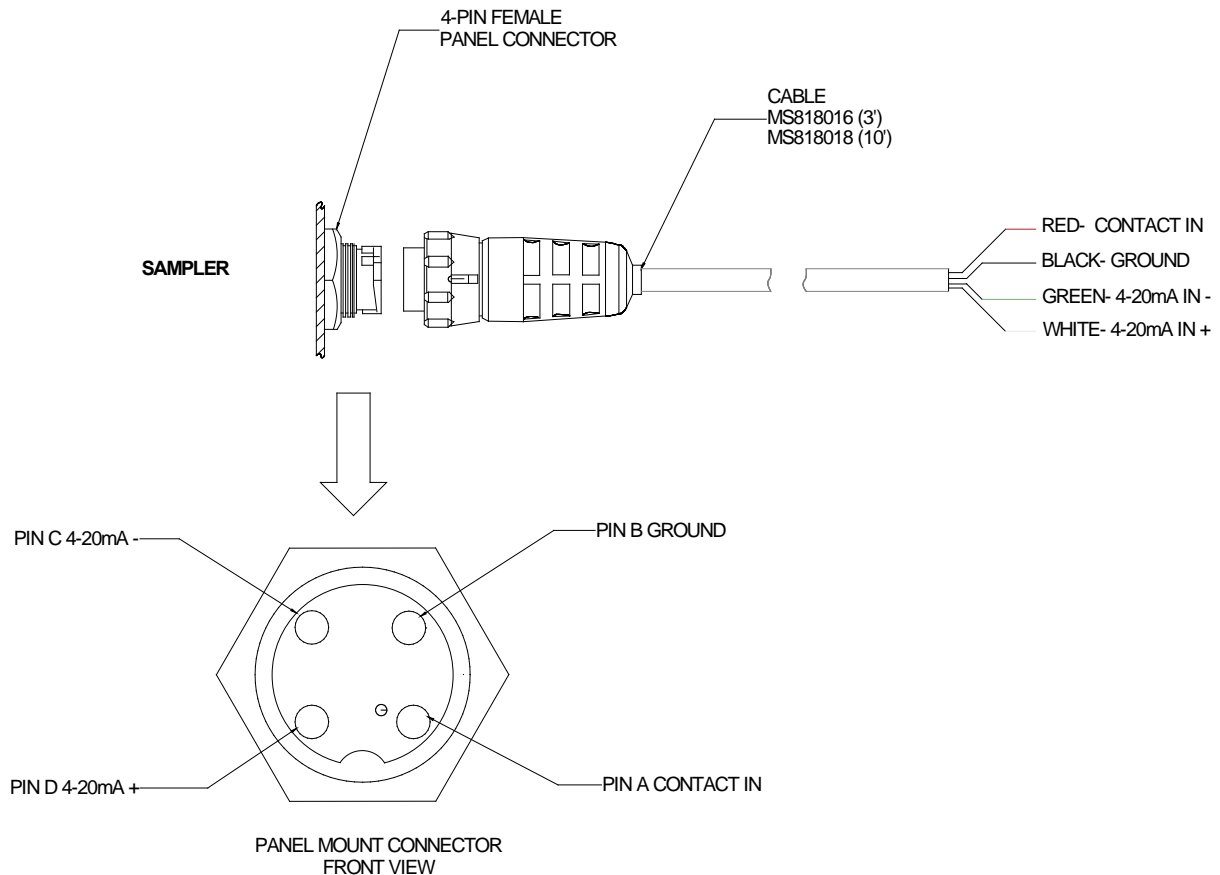

Figure 2.

To use a contact closure, connect your device to the red and black wires on the cable. For a 4-20mA input, connect your device to the green (negative) and white (positive) wires. The contact closure must have a minimum duration of 250 milliseconds. Most devices that provide the contact closure are

not polarity sensitive. If your device is, connect the positive side up to CONTACT IN (red wire on cable). In order to insure proper operation of the sampler, it must be the only device connected to the contact closure output. See Figure 2.

The sampler places a 250-Ohm load on the 4-20mA circuit. In areas where electrical storm activity is possible, Manning recommends connecting surge suppressors by the transmitting device and by the sampler to help prevent damage to the equipment.

For a pulse input, connect your device to the red (positive) and black (negative) wires on the cable. The pulse must have a minimum duration of 1 millisecond. The pulse circuit will work with pulses in the +5 to +15 VDC range, with +12 VDC being the preferred voltage.

Note: The sampler comes configured from the factory for either the contact input or the pulse input. To re-configure the sampler, please contact Manning Technical Support for assistance.

Serial Out Option.

The serial out option proves a way to download the sampler's data log to an RS-232 compatible device such as a computer. A 2-pin female connector on the sampler chassis is provided, along with a serial patch cable, to connect the sampler to the external device. See Figure 3.

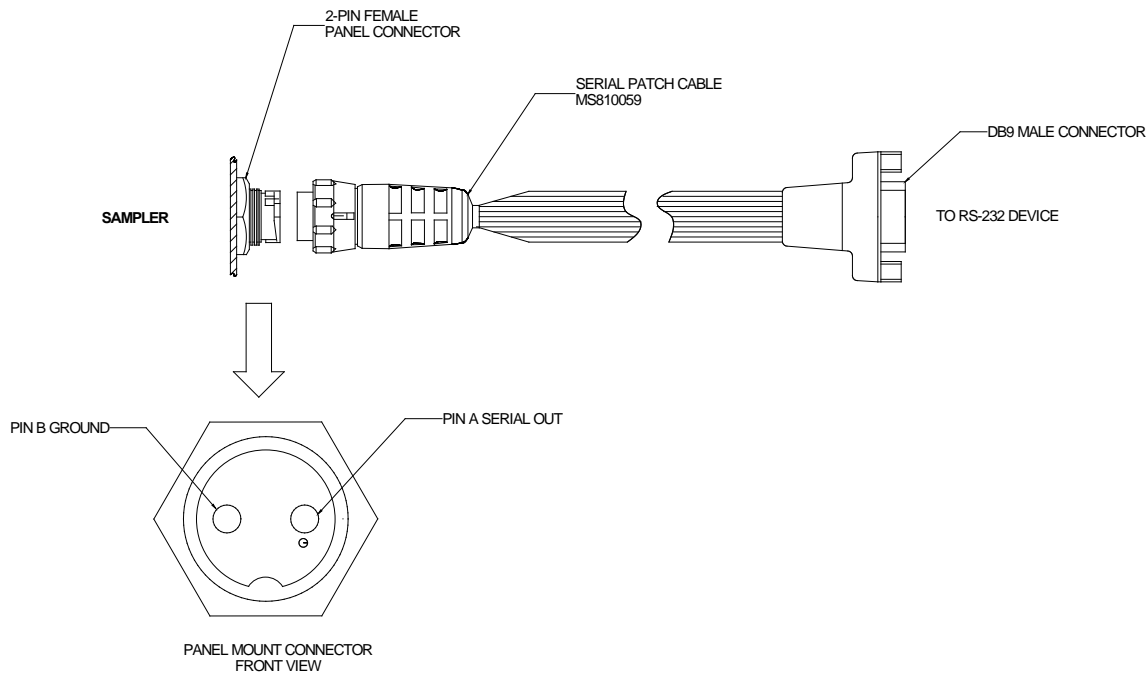

Figure 3.

The user-supplied serial cable that connects the computer or other external device must have a female DB9 connector on the end that will connect to the sampler's patch cable. This cable should be a standard cable, and not a null-modem type.

The serial output from the sampler is fixed at 9600 baud, 8 bits, no parity and 1 stop bit. The data log is output as ASCII text, comma delimited. *91, option 4 is used to download the data log from the sampler. If using a computer to record the data log output from the sampler, a terminal program must be running on the computer.

Sampler Alarm Option.

The alarm option provides three sets of normally open relay contacts that are closed when the sampler detects that certain conditions exist. The relay contacts are rated 5 Amps at 230VAC or 30VDC. A 3-foot (1 Meter) cable connects to the female panel connector on the sampler chassis to allow external alarm connections.

The alarm cable is terminated with six 18-gauge wires in a pigtail. To connect the alarm cable to the sampler, line up the connectors and carefully push the cable connector into the panel connector. Then, secure the cable by tightening the threaded shell. See Figure 4.

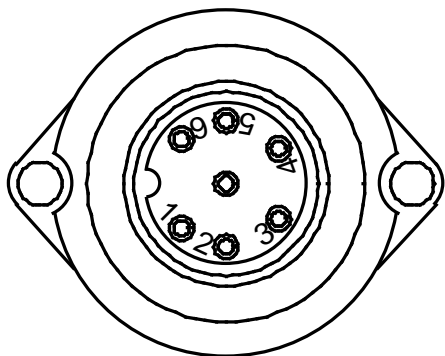
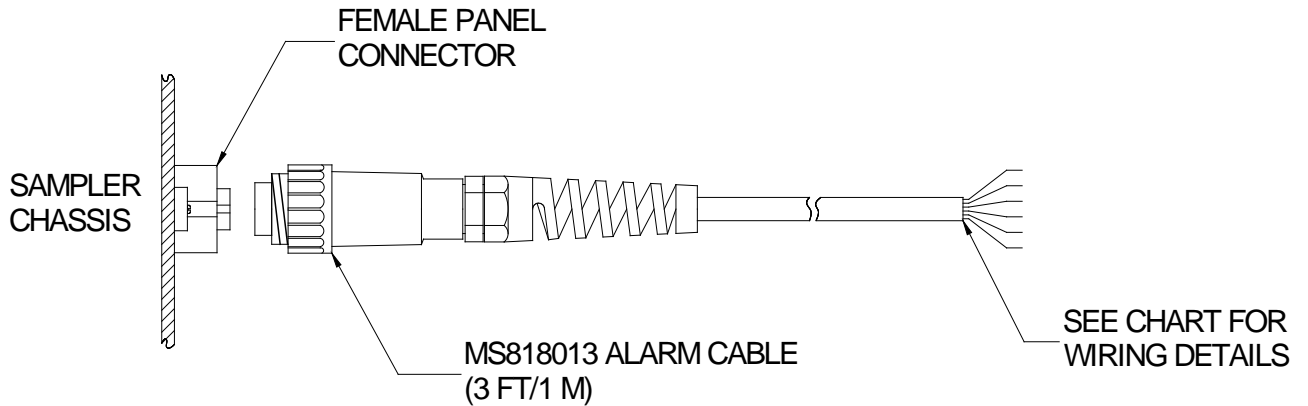

Female Panel Connector Detail

Pin #	Wire Color	Function
1	Black	Sample Cycle
2	Red	
3	White	Missed Sample
4	Green	
5	Orange	Bottle Full/ End of Sequence
6	Blue	

Note: Pin 7 (center) is not used

Figure 4.

The alarms function as follows:

1. Sample Cycle. This set of relay contacts close during the sample cycle, indicating that a sample is in progress.
2. Missed Sample. This set of relay contacts close when the sampler has not successfully taken a sample. The sampler attempts to draw the sample twice. The contacts close at the end of the sample cycle and will remain closed until the sampler is reset, or another sample cycle is started.
3. Bottle Full/End of Sequence. This set of relay contacts close when a bottle full condition is detected on single-bottle (composite) samplers, or when the sampler has completed a sampling sequence (deposited the last sample in the last bottle) on multi-bottle (discrete) samplers.

Stationary Sampler Battery Backup Option.

The battery backup option for stationary samplers allows the sampler to continue to operate when normal AC power is lost for short periods of time. *Backup power is only supplied to the sampler, not the refrigerator.*

The battery backup consists of a 12VDC 8Ahr battery and a dual-stage charger that are mounted outside of the sampler. Inside of the sampler, a relay is used to switch between the battery backup and normal power. A wiring harness connects the battery to the sampler with a two-pin connector.

With AC power present, the charger maintains a charge on the battery, and the sampler's internal +12VDC power supply powers the sampler through the normally open contacts of the relay (the relay is powered by the sampler's power supply). When AC power is lost the relay is de-energized and switches power to the backup battery. See Figure 5.

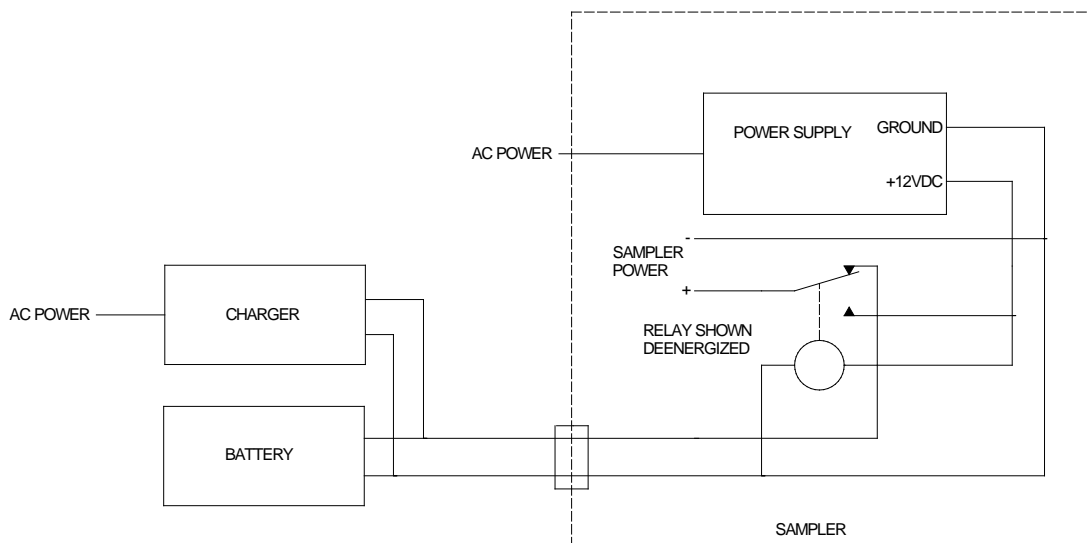

Figure 5.

Prior to operating the sampler, connect the battery to the wiring harness by attaching the insulated faston connectors to the terminals on the battery. The connectors are marked red for positive and black for negative. Connect the charger to AC power with its supplied power cord. The two-pin cable connector on the wiring harness is connected to the BATTERY BACKUP panel connector on the sampler. The battery should be allowed to fully charge before the sampler is put into operation. (For more information on the battery charger, refer to its operating manual.)

When the sampler switches between normal power and battery backup, you may see POWER GLITCH and/or POWER FAIL messages. This is normal due to the lag time of the relay contacts. The sampler must be programmed to auto-restart after a power failure (*99 sampler configuration mode, AUTO RESTART set to 1) for the battery backup to operate correctly.

New Hose Couplings for YB8.

Manning has replaced the MS552104 female and MS552105 male quick-disconnect hose couplings used on YB8 samplers in April 2013. See the table below:

Old Part Number	New Part Number
MS552104 female quick-disconnect coupling	MS552111 3/8" female coupling
MS552105 male quick-disconnect coupling	MS552110 3/8" male coupling

The 3/8" couplings are black in color. The new couplings are more robust, and feature a quarter-turn locking design. The female couplings rotate 360 degrees to help prevent hose kinks. See Figures 6 and 7.



Figure 6. Left- old couplings, Right- new couplings

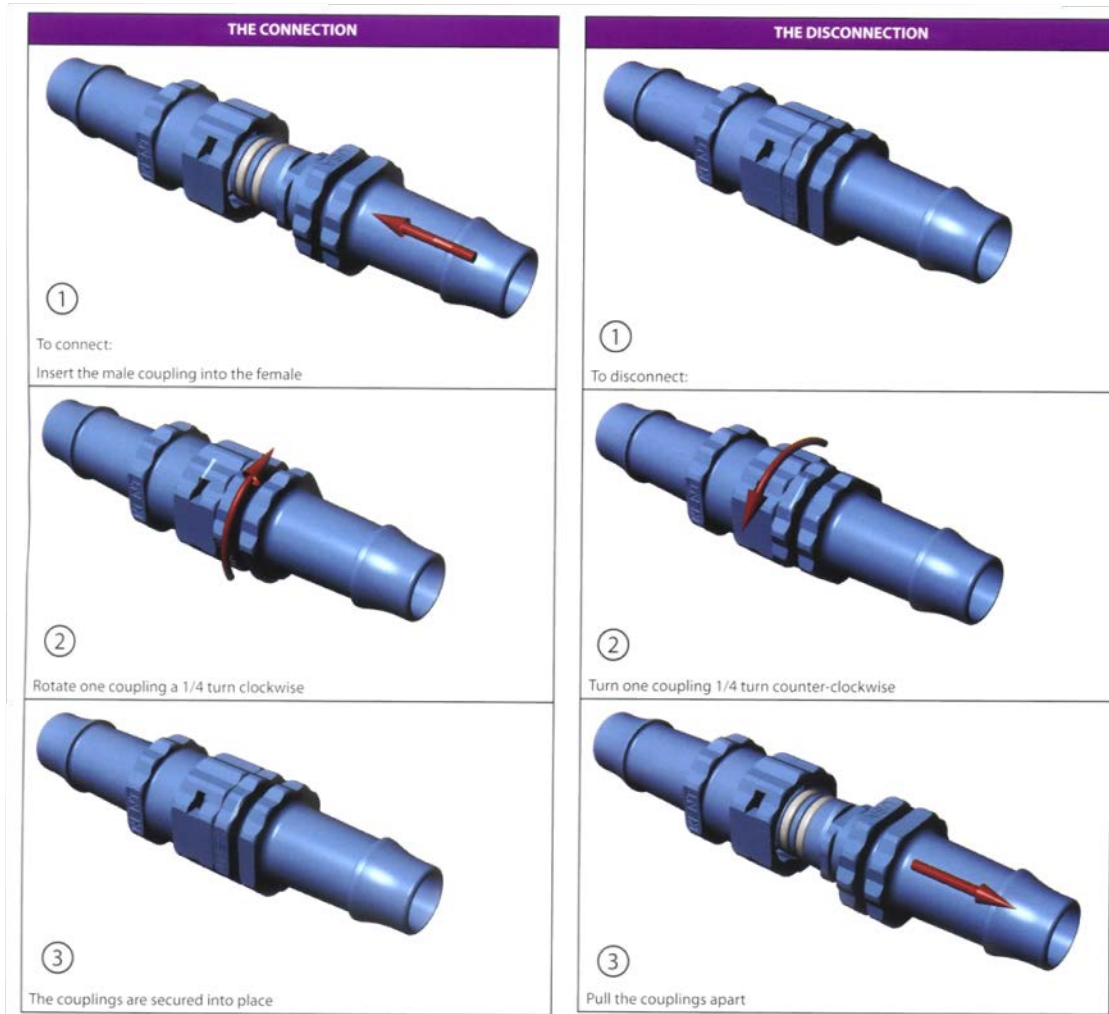

Figure 7. Coupling Operation

The MS552104 and MS552105 quick-disconnect fittings, are still available and will remain so for the foreseeable future. For more information contact Manning Technical Support at (800) 863-9337.

YB8 Sampler Theory of Operation.

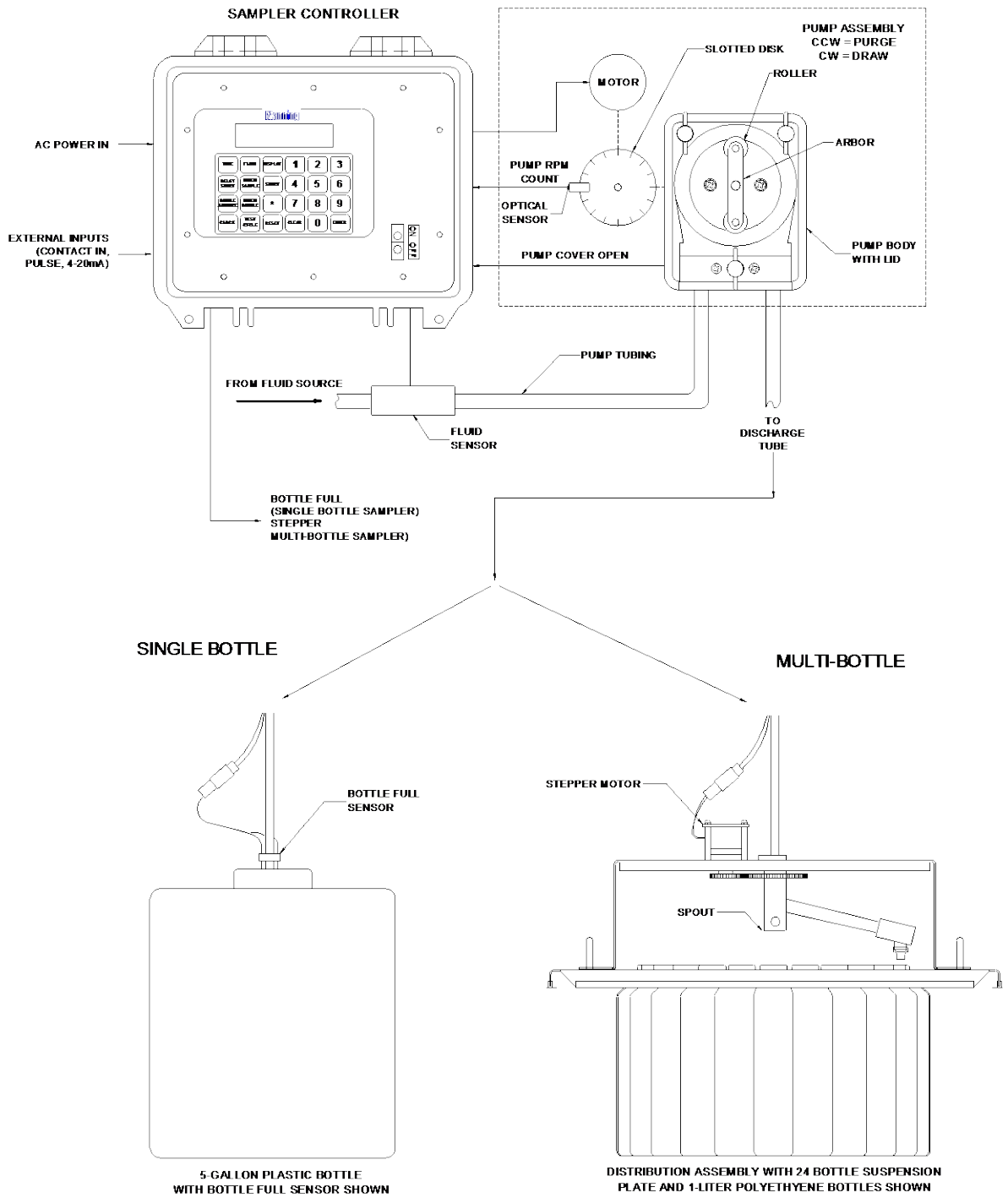

Figure 8. YB8 Sampler Block Diagram.

The sampler uses a peristaltic pump to draw the fluid being sampled into the collection bottle(s). The peristaltic pump produces suction to draw the sample and purges the intake line by squeezing sections of the pump tubing against the inside wall of the pump body using a rotating arbor with two rollers.

The sampler controller includes the processor circuit board, display, and keypad. It provides the logic and processing circuitry to operate the peristaltic pump and associated sampler hardware. It also processes external inputs to the sampler (i.e., contact closure, pulse, or optional 4-20mA input)

The peristaltic pump is mounted to the right side of the yellow controller housing. The black pump body, arbor assembly, and clear lid are visible from the outside. The pump motor, RPM sensor, and associated hardware are mounted inside of the housing.

AC line power (110VAC 60Hz or 220VAC 50Hz) is converted to 12VDC by a power supply located inside of the sampler controller housing. 12VDC is used to power the rest of the sampler electronics (the refrigerator runs directly off the AC line power).

The pump motor receives power from the controller to turn the arbor using a belt drive. The pump rotates in a Counter-clockwise direction (as viewed from the top of the pump) to purge the fluid line and in a Clockwise direction to draw fluid.

The pump also contains an RPM sensor consisting of a slotted disk (mounted directly to the arbor shaft) and optical sensor. The RPM sensor sends pulses to the controller when the pump is rotated. Each pulse represents 1/16th of pump revolution. The RPM sensor pulses are used to measure the amount of fluid being deposited into the sample collection bottle(s). The sampler controller also records the pump revolutions to provide a warning to the operator that the pump tubing is wearing and may need to be replaced. A secondary purpose of the RPM sensor is to provide feedback to the controller that the pump is actually turning. If the sampler received no signal from the RPM sensor when the pump should be turning, the controller turns power to the pump motor off to prevent further damage, and displays a **RPM SENSOR FAIL** message.

The pump is equipped with a safety kill switch to keep the pump from operating without the lid installed. A magnetic reed switch located in the pump body sends a signal to the controller if the pump lid is not installed. The pump lid has a magnet located in it that opens the reed switch when the lid is attached. If the lid is not installed, the switch is closed and the controller will stop the pump from running and display a **PUMP COVER OPEN** message.

Located on the intake side of the sampler pump tubing just before the pump is a fluid sensor, which detects the presence of fluid in the intake line. The controller uses this information to rinse the sampler intake line and to draw the actual sample. The fluid sensor is either a continuity type or an ultrasonic type.

For single bottle samplers, the bottle full sensor located on the discharge tube signals the controller that the bottle is full. This is a continuity probe type of sensor. When the controller senses that the bottle is full, samples are no longer taken.

For multi-bottle samplers, the controller supplies power to the distribution assembly's stepper motor for rotating the spout from bottle to bottle. The spout is advanced (stepped) in a Clockwise direction. Each motor step moves the spout 15 degrees, or one bottle location for a 24-bottle system (360 divided by 24 equals 15).

The sample cycle starts by first purging the intake line to clear it of any residual fluid. If rinses are programmed, the sampler draws fluid up to the fluid sensor and then purges the line. This is

repeated for the number of rinses programmed. The sampler then draws the sample and deposits it into the sample container, using the fluid sensor and RPM sensor to obtain the desired volume of fluid.